

MULTILAYER CERAMIC CAPACITORS

• Head Office

314, Maetan 3-dong, Youngtong-gu,
Suwon, Kyonggi Province 442-743, Korea
Tel: +82-31-210-6794
E-mail: randy.kim@samsung.com

• Manufacturing Site

Suwon Plant

314, Maetan 3-dong, Youngtong-gu,
Suwon, Kyonggi Province 442-743, Korea
Tel: +82-31-218-2063
E-mail: sh386.kim@samsung.com

Pusan Plant

1623-2, Songjong-dong,
Kangso-gu, Pusan 618-270, Korea
Tel: +82-51-970-7741
E-mail: absyong.kim@samsung.com

Tianjin Plant

27, Heiniu, Cheng-Road, Tianjin,
China 300210
Tel: +86-22-2830-3333(3450)
E-mail: gk.ryu@samsung.com

Philippines Plant

Calamba Premiere International Park,
Batino, Calamba, Laguna, Manila
Tel: +63-2-809-2873
E-mail: ksj1445@samsung.com

• America sales office

Irvine Office

92612 3345 Michelson Drive,
Suite 350, Irvine, CA
Tel: 1-949-797-8047
E-mail: banjak@samsung.com

• Europe sales office

Frankfurt Office

D-65824 Samsung Haus am
Knonberger Hang 6 Schwalbach / Ts
Tel: 49-(0)6196-66-7256
E-mail: james.pyun@samsung.com

Hungary Office

H2310, Szigetszentmiklos, Leshegy u.
2-4, Hungary
Tel: 36-24-551-148
E-mail: alex.jung@samsung.com

• Asia sales office

Shanghai Office

200336 Rm 1408 Shanghai international
trade center No 2201 Yan an(W) RD
Shanghai PRC
Tel: 86-21-6270-4168(274)
E-mail: ken.yun@samsung.com

Shenzhen Office

Rm 1903-1907, A 19F, Tianan Cyber
Times Tower, Tianan Cyber park,
Futian District Shenzhen Guang dong
province China
Tel: 86-755-8347-5500(600)
E-mail: harry7.hwang@samsung.com

Qingdao Office

Rm 1201, Crowne Plaza Qingdao;
76XiangGangZhong Rd, Qingdao; 266071
P.R. China
Tel: 86-532-5779102
E-mail: zhengguo.cui@samsung.com

HongKong Office

Suite 4511, Two int'l Finance Centre,
8 Finance Street, Central, Hongkong
Tel: 852-2862-6320
E-mail: sail.park@samsung.com

Singapore Office

239920 83 Clemenceau Avenue
#09-11 UE Square, S'pore
Tel: (65)6833-3219
E-mail: changkuk.cho@samsung.com

Thai Office

Wellgrow Industrial Estate,
93 Moo 5 T. Bangsamak, A. Bangpakong
Chachoengsao 24180 Thailand
Tel: 66-38-562-124
E-mail: skkim79@samsung.com

Taiwan Office

dd 9F-1, Ruey Kuang Rd., Neihu,
Taipei, Taiwan
Tel: 886-2-2656-8360
E-mail: peter.kim@samsung.com

• Domestic Distributors

KORCHIP INC

#219-8 Gasan-dong, Gumchun-gu,
Seoul, Korea
Tel: +82-2-838-5588
E-mail: hjh0064@korchip.com

CHUNG HAN

#16-96 Hangang-lo 3, Youngsan-Gu,
Seoul, Korea
Tel: +82-2-718-3322
E-mail: james.kim@ichunghan.co.kr

SAMTEK

#154-16 Samsung-dong Kangnam-Gu,
Seoul, Korea
Tel: +82-2-3458-9340
E-mail: sinsog1@samtek.co.kr

CHUNGMAC

#53-5 Wonhyolo3 Youngsan-gu,
Seoul, Korea
Tel: +82-2-716-6428~9
E-mail: any@anycam.co.kr

APEXINT

#1258 Gulo-dong Gulo-Gu, Seoul, Korea
Tel: +82-2-6679-5116, 5118
E-mail: djlee@apexint.co.kr





QS 9000/ISO 9001
 Registered by BSI to QS 9000 or ISO 9001 under BSI's accreditation by UKAS for Certification.
 Registration NO : FM25309(2002. 2. 28)
WE WILL PROVIDE A CUSTOMER WITH HIGH RELIABLE PRODUCTS AND SERVICES

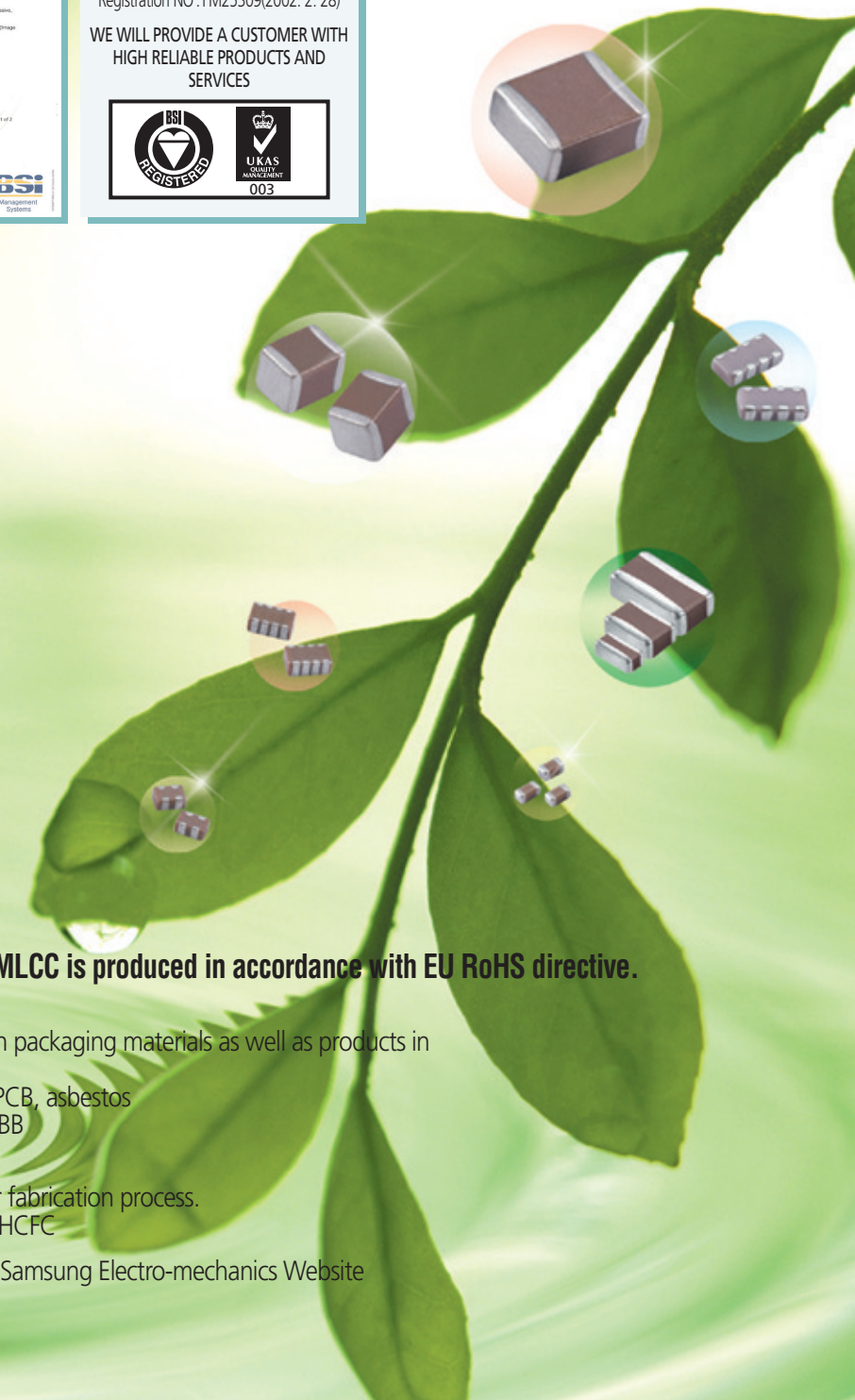

We, Samsung, declare that our component MLCC is produced in accordance with EU RoHS directive.

1. RoHS Compliance and restriction of Br

The following restricted materials are not used in packaging materials as well as products in compliance with the law and restriction.
 - Cd, Pb, Hg, Cr+6, As, Br and the compounds, PCB, asbestos
 - Bromic materials : PBBs, PBBOs, PBDO, PBDE, PBB

2. No use of materials breaking Ozone layer

The following ODS materials are not used in our fabrication process.
 - ODS material : Freon, Haron, 1-1-1 TCE, CCl4, HCFC

If you want more detailed Information, Please Visit Samsung Electro-mechanics Website [http://www.sem.samsung.com]

Quality System Certification List

Table 1: Certification list of Samsung Factory

	SUWON(KOREA)	BUSAN(KOREA)	PHILIPPINES	TIANJIN(CHINA)	THAILAND
ISO / TS 16949	BSI TS 91430-001	BSI TS 91430-001			
QS 9000(Product)			BSI FM 62262		
ISO 9001 (Product)				UL A14163	
TL 9000 (Product)		BSI FM 90588			
ISO 14001	BSI EMS 66454	BSI EMS 66454	BSI EMS 77354	CNAB 02103SI0055ROL	BSI EMS69298
OSHAS 18001	BSI OHS 54734	BSI OHS 54734		CCEMS 012RO	

CONTENTS

Part Numbering System 4

Product Line Up 6

1. General Capacitors
2. Ultra High Capacitors
3. Super Small Capacitors
4. High Voltage Capacitors
5. Array Capacitors
6. Low ESL Capacitors

Packaging Specification 56

Reliability Test Condition 60

1. Appearance
2. Insulation Resistance
3. Withstanding Voltage
4. Capacitance
5. Q Factor / Tan δ
6. Temperature Coefficient of Capacitance
7. Adhesive Strength of Termination
8. Bending Strength
9. Solderability
10. Resistance to Soldering Heat
11. Vibration Test
12. Humidity (Steady State)
13. Moisture Resistance
14. High Temperature Resistance
15. Thermal Cycle
16. Recommended Soldering Method

Application Manual for Surface Mounting 65

1. Recommended Storage Condition
2. Recommended Solder Land Pattern
3. Adhesives
4. Mounting
5. Flux
6. Soldering
7. Notes for Separating Multiple, Shared PC Boards

Part Numbering System

CL 10 A 105 K Q 8 N N N C
 1 2 3 4 5 6 7 8 9 10 11

1. SERIES CODE

CL=Multi layer Ceramic Capacitors

2. SIZE CODE — inch(mm)

03=0201(0603) 21=0805(2012) 42=1808(4520)
 05=0402(1005) 31=1206(3216) 43=1812(4532)
 10=0603(1608) 32=1210(3225) 55=2220(5750)
 14=0504(1410) 01=0306(0816) 12=0508(1220)

3. DIELECTRIC CODE

Class I			Class II	
C=C0G	S=S2H	L=S2L	A=X5R	F=Y5V
P=P2H	T=T2H		B=X7R	X=X6S
R=R2H	U=U2J			

4. CAPACITANCE CODE

Capacitance expressed in pF. 2 significant digits plus number of zeros.
 example) 106=10 × 10⁶=10000000pF
 For Values < 10pF, Letter R denotes decimal point
 example) 1R5=1.5pF

5. TOLERANCE CODE

B=±0.1pF F=±1pF, ±1%* K=±10%
 C=±0.25pF G=±2% M=±20%
 D=±0.5pF J=±5% Z=+80/-20%

*For Values ≤ 10pF, F=±1pF
 Values > 10pF, F=±1%

6. RATED VOLTAGE CODE

R=4V O=16V B=50V E=250V I=1000V
 Q=6.3V A=25V C=100V G=500V J=2000V
 P=10V L=35V D=200V H=630V K=3000V

7. THICKNESS CODE

3 = 0.30mm A = 0.65mm M = 1.15mm I = 2.00mm Q = 1.25mm*
 5 = 0.50mm C = 0.85mm F = 1.25mm J = 2.50mm V = 2.50mm*
 8 = 0.80mm D = 1.00mm H = 1.60mm L = 3.20mm

8. INNER ELECTRODE / TERMINATION / PLATING CODE

A= Normal Product Pd / Ag / Ni barrier / Sn 100%
 N= Normal Product Ni / Cu / Ni barrier / Sn 100%
 G= Normal Product Cu / Cu / Ni barrier / Sn 100%
 L= Low profile Ni / Cu / Ni barrier / Sn 100%

9. PRODUCT CODE

A= Array(2-element) L= LICC
 B= Array(4-element) N= Normal
 P= Automotive

10. SPECIAL CODE

N= Reserved for future use

11. PACKAGING CODE

B= Bulk O= Cardboard Tape, 10" Reel E= Embossed Type, 7" Reel
 P= Bulk Case D= Cardboard Tape, 13" Reel(10,000ea) F= Embossed Type, 13" Reel
 C= Cardboard Tape, 7" Reel L= Cardboard Tape, 13" Reel(15,000ea) S= Embossed Type, 10" Reel

Class I

Symbol	EIA Code	Operation Temperature Range(°C)	Temperature Coefficient Range(ppm/°C)
C	C0G	-55 ~ +125	0 ±30
P	P2H	-55 ~ +125	-150 ±60
R	R2H	-55 ~ +125	-220 ±60
S	S2H	-55 ~ +125	-330 ±60
T	T2H	-55 ~ +125	-470 ±60
U	U2J	-55 ~ +125	-750 ±120
L	S2L	-55 ~ +125	-1000 ~ +350

Class II

Symbol	EIA Code	Operation Temperature Range(°C)	Capacitance Change(ΔC %)
A	X5R	-55 ~ +85	±15
B	X7R	-55 ~ +125	±15
X	X6S	-55 ~ +105	±22
F	Y5V	-30 ~ +85	-82 ~ +22

**

Series	TC	Capacitance Step											
E-3	Y5V	1.0			2.2			4.7					
E-6	X5R X7R X6S	1.0	1.5	2.2	3.3	4.7	6.8						
E-12	C0G TC series	1.0	1.2	1.5	1.8	2.2	2.7	3.3	3.9	4.7	5.6	6.8	8.2

Size	Code	Thickness(mm)	Spec(mm)	Size	Code	Thickness(mm)	Spec(mm)
0201(0603)	3	0.30	±0.03	1210(3225)	H	1.60	±0.20
0402(1005)	5	0.50	±0.05		U	1.80	±0.20
0603(1608)	8	0.80	±0.10		I	2.00	±0.20
0805(2012)	A	0.65	±0.10	1808(4520)	J	2.50	±0.20
	C	0.85	±0.10		*V	2.50	±0.30
	D	1.00	±0.15		F	1.25	±0.20
	F	1.25	±0.10		H	1.60	±0.20
1206(3216)	*Q	1.25	±0.15	1812(4532)	I	2.00	±0.20
	C	0.85	±0.15		J	2.50	±0.20
	D	1.00	±0.15		L	3.20	±0.20
	E	1.10	±0.10		F	1.25	±0.20
1210(3225)	P	1.15	±0.10	2220(5750)	H	1.60	±0.20
	F	1.25	±0.15		I	2.00	±0.20
	H	1.60	±0.20		J	2.50	±0.20
	C	0.85	±0.10		L	3.20	±0.30
1210(3225)	9	0.90	±0.10	2220(5750)	F	1.25	±0.20
	E	1.10	±0.10		H	1.60	±0.20
	M	1.15	±0.10		I	2.00	±0.20
	F	1.25	±0.20		J	2.50	±0.20
	S	1.35	±0.15		L	3.20	±0.30

General Capacitors

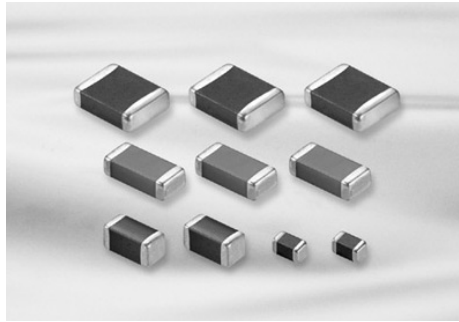

Feature

- Wide selection of size : from 0402 to 2220
- Highly reliable tolerance and high speed automatic chip placement on PCBs
- Wide capacitance range
- Wide temperature compensation and voltage range : from COG to Y5V and from 6.3V to 50V
- Highly reliable performance
- Highly resistant termination metal
- Tape & reel for surface mount assembly

Application

- HHP, DSC, DVC, LCD, TV, Car Navigation, Memory Module, PDA, Game Machine

Structure and Dimensions

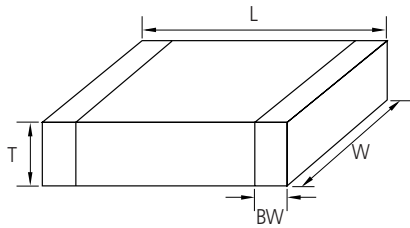

Code	EIA Code	Dimension (mm)			
		L	W	T	BW
05	0402	1.0±0.05	0.5±0.05	0.5±0.05	0.2+0.15/-0.1
10	0603	1.6±0.1	0.8±0.1	0.8±0.1	0.3±0.2
21	0805	2.0±0.1	1.25±0.1	1.25±0.1	0.5+0.2/-0.3
		2.0±0.15	1.25±0.15	1.25±0.15	0.5+0.2/-0.3
31	1206	3.2±0.2	1.6±0.2	1.6±0.2	0.5±0.3
		3.2±0.15	1.6±0.15	0.85±0.15	
32	1210	3.2±0.3	2.5±0.2	2.5±0.2	0.6±0.3
		3.2±0.4	2.5±0.3	2.5±0.3	0.6±0.3
42	1808	4.5±0.4	2.0±0.2	2.0±0.2	0.8±0.3
43	1812	4.5±0.4	3.2±0.3	3.2±0.3	0.8±0.3
55	2220	5.7±0.4	5.0±0.4	3.2±0.3	1.0±0.3

■ Pd MLCC (12th code in part number of pd MLCC = A)

- Class I type
Capacitance < 10pF (Class I. 0402, 0603, 0805 case size)
Capacitance < 18pF (Class I. 1206 case size)

* Except the capacitance range mentioned as above, All other the capacitance range is using Ni inner electrode for Class I, Class II type (12th code in part number of Ni MLCC = N)

Capacitance Table (General Capacitors)

Size	0402(05)	0603(10)	0805(21)	1206(31)	1210(32)	1812(43)	2220(55)
TC	COG(C)						
Rated V	50(B)	50(B)	50(B)	25(A)	50(B)	50(B)	25(A)
Capacitance -pF- (part numbering code) and thickness -mm-							
0.2(0R2)							
0.5(0R5)							
1(010)							
10(100)							
12(120)							
18(180)							
22(220)							
33(330)							
39(390)							
47(470)	0.5 (5)						
56(560)							
100(101)							
150(151)							
180(181)							
220(221)							
270(271)							
330(331)							
390(391)							
470(471)							
560(561)			0.65 (A)				
680(681)							
820(821)							
1000(102)							
1200(122)		0.8 (8)					
1500(152)							
1800(182)							
2200(222)							
2700(272)							
3300(332)							
3900(392)							
4700(472)							
5600(562)			1.25 (F)				
6800(682)				1.25 (F)			
8200(822)							
10000(103)							
12000(123)							
15000(153)							
18000(183)							
22000(223)							
27000(273)							
33000(333)							
39000(393)							
43000(433)							
47000(473)				1.6 (H)		2.0 (D)	
56000(563)							
68000(683)							
100000(104)						1.6 (H)	
120000(124)							2.5 (D)

■ :X7R(B) ■ :X5R(A) ■ :Y5V(F) ■ :COG(C) ■ :X6S(X)

Capacitance Table (General Capacitors)

Size	0402(05)			0603(10)					0805(21)				
	U2J(U)/S2L(L)	T2H(T)	R2H(R)	U2J(U)/S2L(L)	T2H(T)	R2H(R)	S2H(S)	P2H(P)	U2J(U)/S2L(L)	T2H(T)	R2H(R)	S2H(S)	P2H(P)
Rated V	50(B)												
Capacitance -pF- (part numbering code) and thickness -mm-													
0.5(0R5)													
1(010)													
10(100)													
12(120)													
15(150)													
18(180)													
22(220)													
27(270)													
33(330)	0.5(5)	0.5(5)	0.5(5)										
39(390)													
47(470)							0.8(8)	0.8(8)					
56(560)													0.65(A)
68(680)													
82(820)													
100(101)													
120(121)													
150(151)													
180(181)													
220(221)													
270(271)													
330(331)													0.65(A)
390(391)													
470(471)													0.65(A)
560(561)													0.65(A)
680(681)													
820(821)													0.85(C)
1000(102)													0.85(C)
1200(122)													0.85(C)
1500(152)													0.85(C)

Legend: :X7R(B) :X5R(A) :Y5V(F) :COG(C) :X6S(X)

Capacitance Table (General Capacitors)

Size	0402(05)					0603(10)				
	X7R(B) / X5R(A)									
Rated V	6.3(Q)	10(P)	16(O)	25(A)	50(B)	6.3(Q)	10(P)	16(O)	25(A)	50(B)
Capacitance -nF- (part numbering code) and thickness -mm-										
0.10(101)										
0.15(151)										
0.22(221)										
0.33(331)										
0.47(471)										
0.68(681)										
1.0(102)					0.5(5)					
1.5(152)										
2.2(222)										
3.3(332)										0.8(8)
4.7(472)										
6.8(682)										
10(103)										
15(153)				0.5(5)						
22(223)										
33(333)										
47(473)				0.5(5)	0.5(5)					
68(683)										
100(104)										
150(154)										
220(224)										
330(334)										
470(474)										
680(684)										
1000(105)										
1500(155)										
2200(225)										
3300(335)										
4700(475)										
10000(106)										

Legend: :X7R(B) :X5R(A) :Y5V(F) :COG(C) :X6S(X)

Capacitance Table (General Capacitors)

Size	0805(21)					
	X7R(B) / X5R(A)					
TC	4(R)	6.3(Q)	10(P)	16(O)	25(A)	50(B)
Rated V	Capacitance -nF- (part numbering code) and thickness -mm-					
0.15(151)						
0.22(221)						
0.33(331)						
0.47(471)						
0.68(681)						
1.0(102)						
1.5(152)						
2.2(222)						0.65 (A)
3.3(332)						
4.7(472)						
6.8(682)						
10(103)						
15(153)						
22(223)						
33(333)						
47(473)					0.65 (A)	
68(683)					0.85 (C)	
100(104)				0.65 (A)	0.85 (C)	
150(154)						1.25 (F)
220(224)			0.65 (A)			
330(334)			0.85 (C)			
390(394)				0.85 (C)		
470(474)					0.85 (C)	
680(684)				0.85 (C)	0.85 (C)	
1000(105)			1.25 (F)			
1500(155)				1.25 (F)		
2200(225)					1.25 (F)	
3300(335)			0.85 (C)			
4700(475)						
6800(685)			1.25 (F)			
10000(106)						
15000(156)						
22000(226)						
47000(476)						

Legend: :X7R(B) :X5R(A) :Y5V(F) :COG(C) :X6S(X)

Capacitance Table (General Capacitors)

Size	1206(31)					1210(32)				
	X7R(B) / X5R(A)									
TC	6.3(Q)	10(P)	16(O)	25(A)	50(B)	6.3(Q)	10(P)	16(O)	25(A)	50(B)
Rated V	Capacitance -nF- (part numbering code) and thickness -mm-									
1.0(102)										
1.5(152)										
2.2(222)										
3.3(332)										
4.7(472)										
6.8(682)										
10(103)										
15(153)										
22(222)										
33(333)										
47(473)										
68(683)										
100(104)										
150(154)					0.85 (C)					
220(224)					1.25 (F)					
330(334)					0.85 (C)					
470(474)					1.25 (F)					
680(684)					1.6 (H)					
1000(105)					1.25 (F)					
1500(155)					1.6 (H)					
2200(225)					1.6 (H)					
3300(335)					0.85 (C)					
4700(475)					1.6 (H)					
6800(685)					0.85 (C)					
10000(106)	1.6 (H)									
22000(226)										
33000(336)										
47000(476)	1.6 (H)									
68000(686)										
100000(107)										

Legend: :X7R(B) :X5R(A) :Y5V(F) :COG(C) :X6S(X)

Capacitance Table (General Capacitors)

Size	1812(43)					2220(55)		
TC	X7R(B) / X5R(A)							
Rated V	6.3(Q)	10(P)	16(O)	25(A)	50(B)	6.3(Q)	10(P)	25(A)
Capacitance -nF- (part numbering code) and thickness -mm-								
10(103)					1.25 (F)			
1000(105)								
1500(155)								
2200(225)								
3300(335)								
4700(475)				2.5 (J)				
6800(685)								2.5 (J)
10000(106)				3.2 (L)				
15000(156)								
22000(226)		2.5 (J)						
33000(336)							2.5 (J)	
47000(476)	2.5 (J)							
100000(107)	3.2 (L)					2.5 (J)		

Size	0402(05)					0603(10)		
TC	Y5V(F)							
Rated V	6.3(Q)	10(P)	16(O)	25(A)	50(B)	10(P)	16(O)	50(B)
Capacitance -nF- (part numbering code) and thickness -mm-								
2.2(222)					0.50 (5)			
4.7(472)								
10(103)								
22(223)				0.50 (5)				
47(473)								
100(104)			0.50 (5)					0.80 (8)
220(224)								
470(474)		0.80 (8)						
1000(105)	0.80 (8)						0.80 (8)	
2200(225)								
4700(475)						0.80 (8)		

Legend: :X7R(B) :X5R(A) :Y5V(F) :COG(C) :X6S(X)

Capacitance Table (General Capacitors)

Size	0805(21)				1206(31)			
TC	Y5V(F)							
Rated V	10(P)	16(O)	25(A)	50(B)	10(P)	16(O)	25(A)	50(B)
Capacitance -nF- (part numbering code) and thickness -mm-								
2.2(222)								
4.7(472)								
10(103)				0.65 (A)				
22(223)								
47(473)								
100(104)								
220(224)			0.65 (A)					0.85 (C)
470(474)		0.65 (A)	0.85 (C)	1.25 (F)				
1000(105)		0.85 (C)					0.85 (C)	1.25 (F)
2200(225)		1.25 (F)	1.25 (F)			0.85 (C)	1.25 (F)	
4700(475)						1.25 (F)		
10000(106)	1.25 (F)					1.6 (H)		
22000(226)					1.6 (H)			

Size	1210(32)				1812(43)		2220(55)
TC	Y5V(F)						
Rated V	6.3(Q)	10(P)	25(A)	35(L)	16(O)	50(B)	10(P)
Capacitance -nF- (part numbering code) and thickness -mm-							
10(103)							
22(223)							
47(473)							
100(104)							
220(224)							
470(474)							
1000(105)							
2200(225)							
4700(475)			1.6 (H)	1.6 (H)			
10000(106)						2.5 (J)	
22000(226)		2.0 (I)			2.0 (I)		
47000(476)	2.5 (J)						
100000(107)							2.5 (J)

Legend: :X7R(B) :X5R(A) :Y5V(F) :COG(C) :X6S(X)

Product Line UP (General Capacitors)

Part Number	Size L×W (1.0×0.5mm)							Capacitance (pF)	Capacitance Tolerance	Rated Voltage (Vdc)	Thickness max (mm)
	C	P	R	S	T	U	L				
	COG	P2H	R2H	S2H	T2H	U2J	S2L				
CL05○0R2CB5ANN □	●				●	●		0.20	±0.25pF	50	0.55
CL05○0R5CB5ANN □	●				●	●		0.50	±0.25pF	50	0.55
CL05○0R8CB5ANN □	●				●	●		0.80	±0.25pF	50	0.55
CL05○0R82CB5ANN □	●				●	●		0.82	±0.25pF	50	0.55
CL05○0R9CB5ANN □	●				●	●		0.90	±0.25pF	50	0.55
CL05○010CB5ANN □	●				●	●		1.00	±0.25pF	50	0.55
CL05○01R2CB5ANN □	●				●	●		1.20	±0.25pF	50	0.55
CL05○01R5CB5ANN □	●				●	●		1.50	±0.25pF	50	0.55
CL05○01R8CB5ANN □	●				●	●		1.80	±0.25pF	50	0.55
CL05○020CB5ANN □	●				●	●		2.00	±0.25pF	50	0.55
CL05○02R2CB5ANN □	●				●	●		2.20	±0.25pF	50	0.55
CL05○02R7CB5ANN □	●				●	●		2.70	±0.25pF	50	0.55
CL05○030CB5ANN □	●				●	●		3.00	±0.25pF	50	0.55
CL05○03R3CB5ANN □	●				●	●		3.30	±0.25pF	50	0.55
CL05○03R9CB5ANN □	●				●	●		3.90	±0.25pF	50	0.55
CL05○040CB5ANN □	●				●	●		4.00	±0.25pF	50	0.55
CL05○04R7CB5ANN □	●				●	●		4.70	±0.25pF	50	0.55
CL05○050DB5ANN □	●				●	●		5.00	±0.5pF	50	0.55
CL05○05R6DB5ANN □	●				●	●		5.60	±0.5pF	50	0.55
CL05○060DB5ANN □	●				●	●		6.00	±0.5pF	50	0.55
CL05○06R8DB5ANN □	●				●	●		6.80	±0.5pF	50	0.55
CL05○070DB5ANN □	●				●	●		7.00	±0.5pF	50	0.55
CL05○080DB5ANN □	●				●	●		8.00	±0.5pF	50	0.55
CL05○08R2DB5ANN □	●				●	●		8.20	±0.5pF	50	0.55
CL05○090DB5ANN □	●				●	●		9.00	±0.5pF	50	0.55
CL05○100JB5NNN □	●							10	±5%	50	0.55
CL05○120JB5NNN □	●							12	±5%	50	0.55
CL05○120JB5ANN □					●	●		12	±5%	50	0.55
CL05○150JB5NNN □	●							15	±5%	50	0.55
CL05○180JB5NNN □	●							18	±5%	50	0.55
CL05○220JB5NNN □	●							22	±5%	50	0.55
CL05○270JB5NNN □	●							27	±5%	50	0.55
CL05○270JB5ANN □					●	●		27	±5%	50	0.55
CL05○330JB5NNN □	●							33	±5%	50	0.55
CL05○330JB5ANN □					●	●		33	±5%	50	0.55

※ ○ mark means temperature characteristic code. The parts with mark ● are available to produce.

※ □ mark means packaging code. If you want to learn the code or quantity in detail, please see p 58.

Product Line UP (General Capacitors)

Part Number	Size L×W (1.0×0.5mm)							Capacitance (pF)	Capacitance Tolerance	Rated Voltage (Vdc)	Thickness max (mm)
	C	P	R	S	T	U	L				
	COG	P2H	R2H	S2H	T2H	U2J	S2L				
CL05○390JB5NNN □	●							39	±5%	50	0.55
CL05○390JB5ANN □					●	●		39	±5%	50	0.55
CL05○470JB5NNN □	●							47	±5%	50	0.55
CL05○470JB5ANN □					●	●		47	±5%	50	0.55
CL05○560JB5NNN □	●							56	±5%	50	0.55
CL05○560JB5ANN □					●	●		56	±5%	50	0.55
CL05○680JB5NNN □	●							68	±5%	50	0.55
CL05○680JB5ANN □					●	●		68	±5%	50	0.55
CL05○820JB5NNN □	●							82	±5%	50	0.55
CL05○820JB5ANN □						●		82	±5%	50	0.55
CL05○101JB5NNN □	●							100	±5%	50	0.55
CL05○101JB5ANN □						●		100	±5%	50	0.55
CL05○121JB5NNN □	●							120	±5%	50	0.55
CL05○151JB5NNN □	●							150	±5%	50	0.55
CL05○151JB5ANN □						●		150	±5%	50	0.55
CL05○181JB5NNN □	●							180	±5%	50	0.55
CL05○221JB5NNN □	●							220	±5%	50	0.55
CL05○271JB5NNN □	●							270	±5%	50	0.55
CL05○331JB5NNN □	●							330	±5%	50	0.55
CL05○471JB5NNN □	●							470	±5%	50	0.55

Part Number	Size L×W (1.6×0.8mm)							Capacitance (pF)	Capacitance Tolerance	Rated Voltage (Vdc)	Thickness max (mm)
	C	P	R	S	T	U	L				
	COG	P2H	R2H	S2H	T2H	U2J	S2L				
CL10○0R2CB8ANN □	●		●	●	●	●	●	0.20	±0.25pF	50	0.90
CL10○0R3CB8ANN □	●		●	●	●	●	●	0.30	±0.25pF	50	0.90
CL10○0R4CB8ANN □	●		●	●	●	●	●	0.40	±0.25pF	50	0.90
CL10○0R47CB8ANN □	●		●	●	●	●	●	0.47	±0.25pF	50	0.90
CL10○0R5CB8ANN □	●		●	●	●	●	●	0.50	±0.25pF	50	0.90
CL10○0R56CB8ANN □	●		●	●	●	●	●	0.56	±0.25pF	50	0.90
CL10○0R68CB8ANN □	●		●	●	●	●	●	0.68	±0.25pF	50	0.90
CL10○0R7CB8ANN □	●		●	●	●	●	●	0.70	±0.25pF	50	0.90
CL10○0R8CB8ANN □	●		●	●	●	●	●	0.80	±0.25pF	50	0.90

※ ○ mark means temperature characteristic code. The parts with mark ● are available to produce.

※ □ mark means packaging code. If you want to learn the code or quantity in detail, please see p 58.

Product Line UP (General Capacitors)

Part Number	Size L×W (1.6×0.8mm)							Capacitance (pF)	Capacitance Tolerance	Rated Voltage (Vdc)	Thickness max (mm)
	C	P	R	S	T	U	L				
	COG	P2H	R2H	S2H	T2H	U2J	S2L				
CL10○R82CB8ANN □	●		●	●	●	●	●	0.82	±0.25pF	50	0.90
CL10○010CB8ANN □	●		●	●	●	●	●	1.00	±0.25pF	50	0.90
CL10○1R2CB8ANN □	●		●	●	●	●	●	1.20	±0.25pF	50	0.90
CL10○1R5CB8ANN □	●		●	●	●	●	●	1.50	±0.25pF	50	0.90
CL10○1R8CB8ANN □	●		●	●	●	●	●	1.80	±0.25pF	50	0.90
CL10○020CB8ANN □	●		●	●	●	●	●	2.00	±0.25pF	50	0.90
CL10○2R2CB8ANN □	●		●	●	●	●	●	2.20	±0.25pF	50	0.90
CL10○2R7CB8ANN □	●		●	●	●	●	●	2.70	±0.25pF	50	0.90
CL10○030CB8ANN □	●		●	●	●	●	●	3.00	±0.25pF	50	0.90
CL10○3R3CB8ANN □	●		●	●	●	●	●	3.30	±0.25pF	50	0.90
CL10○3R9CB8ANN □	●		●	●	●	●	●	3.90	±0.25pF	50	0.90
CL10○040CB8ANN □	●		●	●	●	●	●	4.00	±0.25pF	50	0.90
CL10○4R7CB8ANN □	●		●	●	●	●	●	4.70	±0.25pF	50	0.90
CL10○050DB8ANN □	●		●	●	●	●	●	5.00	±0.5pF	50	0.90
CL10○5R6DB8ANN □	●		●	●	●	●	●	5.60	±0.5pF	50	0.90
CL10○060DB8ANN □	●		●	●	●	●	●	6.00	±0.5pF	50	0.90
CL10○6R8DB8ANN □	●		●	●	●	●	●	6.80	±0.5pF	50	0.90
CL10○070DB8ANN □	●		●	●	●	●	●	7.00	±0.5pF	50	0.90
CL10○080DB8ANN □	●		●	●	●	●	●	8.00	±0.5pF	50	0.90
CL10○8R2DB8ANN □	●		●	●	●	●	●	8.20	±0.5pF	50	0.90
CL10○090DB8ANN □	●		●	●	●	●	●	9.00	±0.5pF	50	0.90
CL10○100JB8NNN □	●							10	±5%	50	0.90
CL10○100JB8ANN □			●	●	●	●	●	10	±5%	50	0.90
CL10○120JB8NNN □	●							12	±5%	50	0.90
CL10○120JB8ANN □			●	●	●	●	●	12	±5%	50	0.90
CL10○150JB8NNN □	●							15	±5%	50	0.90
CL10○150JB8ANN □			●	●	●	●	●	15	±5%	50	0.90
CL10○180JB8NNN □	●							18	±5%	50	0.90
CL10○180JB8ANN □			●	●	●	●	●	18	±5%	50	0.90
CL10○220JB8NNN □	●							22	±5%	50	0.90
CL10○220JB8ANN □			●	●	●	●	●	22	±5%	50	0.90
CL10○270JB8NNN □	●							27	±5%	50	0.90
CL10○270JB8ANN □			●		●	●	●	27	±5%	50	0.90
CL10○330JB8NNN □	●							33	±5%	50	0.90
CL10○330JB8ANN □			●		●	●	●	33	±5%	50	0.90

※ ○ mark means temperature characteristic code. The parts with mark ● are available to produce.
 ※ □ mark means packaging code. If you want to learn the code or quantity in detail, please see p 58.

Product Line UP (General Capacitors)

Part Number	Size L×W (1.6×0.8mm)							Capacitance (pF)	Capacitance Tolerance	Rated Voltage (Vdc)	Thickness max (mm)
	C	P	R	S	T	U	L				
	COG	P2H	R2H	S2H	T2H	U2J	S2L				
CL10○390JB8NNN □	●							39	±5%	50	0.90
CL10○390JB8ANN □			●		●	●	●	39	±5%	50	0.90
CL10○470JB8NNN □	●							47	±5%	50	0.90
CL10○470JB8ANN □			●		●	●	●	47	±5%	50	0.90
CL10○560JB8NNN □	●							56	±5%	50	0.90
CL10○560JB8ANN □			●		●	●		56	±5%	50	0.90
CL10○680JB8NNN □	●							68	±5%	50	0.90
CL10○680JB8ANN □			●		●	●		68	±5%	50	0.90
CL10○820JB8NNN □	●							82	±5%	50	0.90
CL10○820JB8ANN □			●		●	●		82	±5%	50	0.90
CL10○101JB8NNN □	●							100	±5%	50	0.90
CL10○101JB8ANN □			●		●	●		100	±5%	50	0.90
CL10○121JB8NNN □	●							120	±5%	50	0.90
CL10○121JB8ANN □			●		●	●		120	±5%	50	0.90
CL10○151JB8NNN □	●							150	±5%	50	0.90
CL10○151JB8ANN □			●		●	●		150	±5%	50	0.90
CL10○181JB8NNN □	●							180	±5%	50	0.90
CL10○181JB8ANN □			●		●	●		180	±5%	50	0.90
CL10○221JB8NNN □	●							220	±5%	50	0.90
CL10○221JB8ANN □					●	●		220	±5%	50	0.90
CL10○271JB8NNN □	●							270	±5%	50	0.90
CL10○271JB8ANN □					●	●		270	±5%	50	0.90
CL10○331JB8NNN □	●							330	±5%	50	0.90
CL10○331JB8ANN □					●	●		330	±5%	50	0.90
CL10○391JB8NNN □	●							390	±5%	50	0.90
CL10○471JB8NNN □	●							470	±5%	50	0.90
CL10○471JB8ANN □						●		470	±5%	50	0.90
CL10○561JB8NNN □	●							560	±5%	50	0.90
CL10○681JB8NNN □	●							680	±5%	50	0.90
CL10○681JB8ANN □						●		680	±5%	50	0.90
CL10○821JB8NNN □	●							820	±5%	50	0.90
CL10○102JB8NNN □	●							1000	±5%	50	0.90
CL10○122JB8NNN □	●							1200	±5%	50	0.90
CL10○222JB8NNN □	●							2200	±5%	50	0.90
CL10○332JA8NNN □	●							3300	±5%	25	0.90

※ ○ mark means temperature characteristic code. The parts with mark ● are available to produce.
 ※ □ mark means packaging code. If you want to learn the code or quantity in detail, please see p 58.

Product Line UP (General Capacitors)

Part Number	Size L × W (2.0 × 1.25mm)							Capacitance (pF)	Capacitance Tolerance	Rated Voltage (Vdc)	Thickness max (mm)
	C	P	R	S	T	U	L				
	COG	P2H	R2H	S2H	T2H	U2J	S2L				
CL21 ○ R47CBAANN □	●	●	●	●	●	●	●	0.47	±0.25pF	50	0.75
CL21 ○ 0R5CBAANN □	●	●	●	●	●	●	●	0.50	±0.25pF	50	0.75
CL21 ○ R68CBAANN □	●	●	●	●	●	●	●	0.68	±0.25pF	50	0.75
CL21 ○ R82CBAANN □	●	●	●	●	●	●	●	0.82	±0.25pF	50	0.75
CL21 ○ 010CBAANN □	●	●	●	●	●	●	●	1.00	±0.25pF	50	0.75
CL21 ○ 1R2CBAANN □	●	●	●	●	●	●	●	1.20	±0.25pF	50	0.75
CL21 ○ 1R5CBAANN □	●	●	●	●	●	●	●	1.50	±0.25pF	50	0.75
CL21 ○ 1R8CBAANN □	●	●	●	●	●	●	●	1.80	±0.25pF	50	0.75
CL21 ○ 020CBAANN □	●	●	●	●	●	●	●	2.00	±0.25pF	50	0.75
CL21 ○ 2R2CBAANN □	●	●	●	●	●	●	●	2.20	±0.25pF	50	0.75
CL21 ○ 2R7CBAANN □	●	●	●	●	●	●	●	2.70	±0.25pF	50	0.75
CL21 ○ 030CBAANN □	●	●	●	●	●	●	●	3.00	±0.25pF	50	0.75
CL21 ○ 3R3CBAANN □	●	●	●	●	●	●	●	3.30	±0.25pF	50	0.75
CL21 ○ 3R9CBAANN □	●	●	●	●	●	●	●	3.90	±0.25pF	50	0.75
CL21 ○ 040CBAANN □	●	●	●	●	●	●	●	4.00	±0.25pF	50	0.75
CL21 ○ 4R7CBAANN □	●	●	●	●	●	●	●	4.70	±0.25pF	50	0.75
CL21 ○ 050DBAANN □	●	●	●	●	●	●	●	5.00	±0.5pF	50	0.75
CL21 ○ 5R6DBAANN □	●	●	●	●	●	●	●	5.60	±0.5pF	50	0.75
CL21 ○ 060DBAANN □	●	●	●	●	●	●	●	6.00	±0.5pF	50	0.75
CL21 ○ 6R8DBAANN □	●	●	●	●	●	●	●	6.80	±0.5pF	50	0.75
CL21 ○ 070DBAANN □	●	●	●	●	●	●	●	7.00	±0.5pF	50	0.75
CL21 ○ 080DBAANN □	●	●	●	●	●	●	●	8.00	±0.5pF	50	0.75
CL21 ○ 8R2DBAANN □	●	●	●	●	●	●	●	8.20	±0.5pF	50	0.75
CL21 ○ 090DBAANN □	●	●	●	●	●	●	●	9.00	±0.5pF	50	0.75
CL21 ○ 100JBANNN □	●							10	±5%	50	0.75
CL21 ○ 100JBAANN □			●	●	●	●	●	10	±5%	50	0.75
CL21 ○ 120JBANNN □	●							12	±5%	50	0.75
CL21 ○ 120JBAANN □			●	●	●	●	●	12	±5%	50	0.75
CL21 ○ 150JBANNN □	●							15	±5%	50	0.75
CL21 ○ 180JBANNN □	●							18	±5%	50	0.75
CL21 ○ 220JBANNN □	●							22	±5%	50	0.75
CL21 ○ 270JBANNN □	●							27	±5%	50	0.75
CL21 ○ 330JBANNN □	●							33	±5%	50	0.75
CL21 ○ 390JBANNN □	●							39	±5%	50	0.75
CL21 ○ 470JBANNN □	●							47	±5%	50	0.75

※ ○ mark means temperature characteristic code. The parts with mark ● are available to produce.
 ※ □ mark means packaging code. If you want to learn the code or quantity in detail, please see p 58.

Product Line UP (General Capacitors)

Part Number	Size L × W (2.0 × 1.25mm)							Capacitance (pF)	Capacitance Tolerance	Rated Voltage (Vdc)	Thickness max (mm)
	C	P	R	S	T	U	L				
	COG	P2H	R2H	S2H	T2H	U2J	S2L				
CL21 ○ 560JBANNN □	●							56	±5%	50	0.75
CL21 ○ 680JBANNN □	●							68	±5%	50	0.75
CL21 ○ 820JBANNN □	●							82	±5%	50	0.75
CL21 ○ 101JBANNN □	●							100	±5%	50	0.75
CL21 ○ 101JBAANN □			●	●	●	●	●	100	±5%	50	0.75
CL21 ○ 121JBANNN □	●							120	±5%	50	0.75
CL21 ○ 151JBANNN □	●							150	±5%	50	0.75
CL21 ○ 181JBANNN □	●							180	±5%	50	0.75
CL21 ○ 221JBANNN □	●							220	±5%	50	0.75
CL21 ○ 271JBANNN □	●							270	±5%	50	0.75
CL21 ○ 331JBANNN □	●							330	±5%	50	0.75
CL21 ○ 331JBAANN □			●	●	●	●	●	330	±5%	50	0.75
CL21 ○ 391JBANNN □	●							390	±5%	50	0.75
CL21 ○ 471JBANNN □	●							470	±5%	50	0.75
CL21 ○ 471JBAANN □			●	●	●	●	●	470	±5%	50	0.75
CL21 ○ 561JBANNN □	●							560	±5%	50	0.75
CL21 ○ 821JBCNNN □	●							820	±5%	50	0.95
CL21 ○ 821JBAANN □			●	●	●	●	●	820	±5%	50	0.75
CL21 ○ 102JBCNNN □	●							1000	±5%	50	0.95
CL21 ○ 122JBFNNN □	●							1200	±5%	50	1.35
CL21 ○ 152JBFNNN □	●							1500	±5%	50	1.35
CL21 ○ 182JBFNNN □	●							1800	±5%	50	1.35
CL21 ○ 222JBFNNN □	●							2200	±5%	50	1.35
CL21 ○ 332JAFNNN □	●							3300	±5%	25	1.35
CL21 ○ 332JBFNNN □	●							3300	±5%	50	1.35
CL21 ○ 392JBFNNN □	●							3900	±5%	50	1.35
CL21 ○ 472JAFNNN □	●							4700	±5%	25	1.35
CL21 ○ 472JBFNNN □	●							4700	±5%	50	1.35
CL21 ○ 562JBFNNN □	●							5600	±5%	50	1.35
CL21 ○ 103JBFNNN □	●							10000	±5%	50	1.35

※ ○ mark means temperature characteristic code. The parts with mark ● are available to produce.
 ※ □ mark means packaging code. If you want to learn the code or quantity in detail, please see p 58.

Product Line UP (General Capacitors)

Part Number	Size L×W (3.2×1.6(2.5)mm)							Capacitance (pF)	Capacitance Tolerance	Rated Voltage (Vdc)	Thickness max (mm)
	C	P	R	S	T	U	L				
	COG	P2H	R2H	S2H	T2H	U2J	S2L				
CL31 ○ 122JBCNNN □	●							1200	±5%	50	0.75
CL31 ○ 152JBCNNN □	●							1500	±5%	50	0.75
CL31 ○ 182JBCNNN □	●							1800	±5%	50	0.75
CL31 ○ 222JBCNNN □	●							2200	±5%	50	0.75
CL31 ○ 472JBFNNN □	●							4700	±5%	50	1.35
CL31 ○ 562JBHNNN □	●							5600	±5%	50	1.80
CL31 ○ 682JBHNNN □	●							6800	±5%	50	1.80
CL31 ○ 103JAFNNN □	●							10000	±5%	25	1.35
CL32 ○ 103JBFNNN □	●							10000	±5%	50	1.35

Part Number	Size L×W (1.0×0.5mm)			Capacitance	Capacitance Tolerance	Rated Voltage (Vdc)	Thickness max (mm)
	A	B	F				
	X5R(EIA)	X7R(EIA)	Y5V(EIA)				
CL05 ○ 221KB5NNN □		●		0.22nF	±10%	50	0.55
CL05 ○ 331KB5NNN □		●		0.33nF	±10%	50	0.55
CL05 ○ 471KB5NNN □		●		0.47nF	±10%	50	0.55
CL05 ○ 681KB5NNN □		●		0.68nF	±10%	50	0.55
CL05 ○ 102KB5NNN □		●		1.0nF	±10%	50	0.55
CL05 ○ 152KB5NNN □		●		1.5nF	±10%	50	0.55
CL05 ○ 222KB5NNN □		●		2.2nF	±10%	50	0.55
CL05 ○ 332KB5NNN □		●		3.3nF	±10%	50	0.55
CL05 ○ 472KB5NNN □		●		4.7nF	±10%	50	0.55
CL05 ○ 682KB5NNN □		●		6.8nF	±10%	50	0.55
CL05 ○ 103KB5NNN □		●		10nF	±10%	50	0.55
CL05 ○ 103ZB5NNN □			●	10nF	+80%~-20%	50	0.55
CL05 ○ 102KA5NNN □		●		10nF	±10%	25	0.55
CL05 ○ 222KA5NNN □		●		2.2nF	±10%	25	0.55
CL05 ○ 332KA5NNN □		●		3.3nF	±10%	25	0.55
CL05 ○ 472KA5NNN □		●		4.7nF	±10%	25	0.55
CL05 ○ 682KA5NNN □		●		6.8nF	±10%	25	0.55
CL05 ○ 103KA5NNN □		●		10nF	±10%	25	0.55

※ ○ mark means temperature characteristic code. The parts with mark ● are available to produce.

※ □ mark means packaging code. If you want to learn the code or quantity in detail, please see p 58.

Product Line UP (General Capacitors)

Part Number	Size L×W (1.0×0.5mm)			Capacitance	Capacitance Tolerance	Rated Voltage (Vdc)	Thickness max (mm)
	A	B	F				
	X5R(EIA)	X7R(EIA)	Y5V(EIA)				
CL05 ○ 153KA5NNN □		●		15nF	±10%	25	0.55
CL05 ○ 223KA5NNN □		●		22nF	±10%	25	0.55
CL05 ○ 223ZA5NNN □			●	22nF	+80%~-20%	25	0.55
CL05 ○ 102KO5NNN □		●		1.0nF	±10%	16	0.55
CL05 ○ 472KO5NNN □		●		4.7nF	±10%	16	0.55
CL05 ○ 682KO5NNN □		●		6.8nF	±10%	16	0.55
CL05 ○ 103KO5NNN □		●		10nF	±10%	16	0.55
CL05 ○ 103ZO5NNN □			●	10nF	+80%~-20%	16	0.55
CL05 ○ 153KO5NNN □		●		15nF	±10%	16	0.55
CL05 ○ 223KO5NNN □		●		22nF	±10%	16	0.55
CL05 ○ 223ZO5NNN □			●	22nF	+80%~-20%	16	0.55
CL05 ○ 333KO5NNN □		●		33nF	±10%	16	0.55
CL05 ○ 473KO5NNN □		●		47nF	±10%	16	0.55
CL05 ○ 473ZO5NNN □			●	47nF	+80%~-20%	16	0.55
CL05 ○ 683KO5NNN □		●		68nF	±10%	16	0.55
CL05 ○ 104KO5NNN □	●	●		100nF	±10%	16	0.55
CL05 ○ 104ZO5NNN □			●	100nF	+80%~-20%	16	0.55
CL05 ○ 224ZO5NNN □			●	220nF	+80%~-20%	16	0.55
CL05 ○ 103KP5NNN □		●		10nF	±10%	10	0.55
CL05 ○ 333KP5NNN □		●		33nF	±10%	10	0.55
CL05 ○ 473KP5NNN □		●		47nF	±10%	10	0.55
CL05 ○ 683KP5NNN □		●		68nF	±10%	10	0.55
CL05 ○ 104KP5NNN □	●	●		100nF	±10%	10	0.55
CL05 ○ 224ZP5NNN □			●	220nF	+80%~-20%	10	0.55
CL05 ○ 474ZP5NNN □			●	470nF	+80%~-20%	10	0.55
CL05 ○ 104KQ5NNN □	●	●		100nF	±10%	6.3	0.55
CL05 ○ 474KQ5NNN □			●	470nF	+80%~-20%	6.3	0.55

※ ○ mark means temperature characteristic code. The parts with mark ● are available to produce.

※ □ mark means packaging code. If you want to learn the code or quantity in detail, please see p 58.

Product Line UP (General Capacitors)

Part Number	Size L×W (1.6×0.8mm)			Capacitance	Capacitance Tolerance	Rated Voltage (Vdc)	Thickness max (mm)
	A	B	F				
	X5R(EIA)	X7R(EIA)	Y5V(EIA)				
CL10○101KB8NNN □		●		0.10nF	±10%	50	0.90
CL10○151KB8NNN □		●		0.15nF	±10%	50	0.90
CL10○221KB8NNN □		●		0.22nF	±10%	50	0.90
CL10○331KB8NNN □		●		0.33nF	±10%	50	0.90
CL10○471KB8NNN □		●		0.47nF	±10%	50	0.90
CL10○681KB8NNN □		●		0.68nF	±10%	50	0.90
CL10○102KB8NNN □		●		1.0nF	±10%	50	0.90
CL10○152KB8NNN □		●		1.5nF	±10%	50	0.90
CL10○222KB8NNN □		●		2.2nF	±10%	50	0.90
CL10○332KB8NNN □		●		3.3nF	±10%	50	0.90
CL10○472KB8NNN □		●		4.7nF	±10%	50	0.90
CL10○682KB8NNN □		●		6.8nF	±10%	50	0.90
CL10○103KB8NNN □		●		10nF	±10%	50	0.90
CL10○103ZB8NNN □			●	10nF	+80%~-20%	50	0.90
CL10○153KB8NNN □		●		15nF	±10%	50	0.90
CL10○223KB8NNN □		●		22nF	±10%	50	0.90
CL10○223ZB8NNN □			●	22nF	+80%~-20%	50	0.90
CL10○333KB8NNN □		●		33nF	±10%	50	0.90
CL10○473KB8NNN □		●		47nF	±10%	50	0.90
CL10○473ZB8NNN □			●	47nF	+80%~-20%	50	0.90
CL10○683KB8NNN □		●		68nF	±10%	50	0.90
CL10○104KB8NNN □		●		100nF	±10%	50	0.90
CL10○104ZB8NNN □			●	100nF	+80%~-20%	50	0.90
CL10○224ZB8NNN □			●	220nF	+80%~-20%	50	0.90
CL10○474ZB8NNN □			●	470nF	+80%~-20%	50	0.90
CL10○102KA8NNN □		●		1.0nF	±10%	25	0.90
CL10○472KA8NNN □		●		4.7nF	±10%	25	0.90
CL10○682KA8NNN □		●		6.8nF	±10%	25	0.90
CL10○103KA8NNN □		●		10nF	±10%	25	0.90
CL10○153KA8NNN □		●		15nF	±10%	25	0.90
CL10○223KA8NNN □		●		22nF	±10%	25	0.90
CL10○223ZA8NNN □			●	22nF	+80%~-20%	25	0.90
CL10○333KA8NNN □		●		33nF	±10%	25	0.90
CL10○473KA8NNN □		●		47nF	±10%	25	0.90
CL10○473ZA8NNN □			●	47nF	+80%~-20%	25	0.90

※ ○ mark means temperature characteristic code. The parts with mark ● are available to produce.

※ □ mark means packaging code. If you want to learn the code or quantity in detail, please see p 58.

Product Line UP (General Capacitors)

Part Number	Size L×W (1.6×0.8mm)			Capacitance	Capacitance Tolerance	Rated Voltage (Vdc)	Thickness max (mm)
	A	B	F				
	X5R(EIA)	X7R(EIA)	Y5V(EIA)				
CL10○683KA8NNN □		●		68nF	±10%	25	0.90
CL10○104KA8NNN □		●		100nF	±10%	25	0.90
CL10○104ZA8NNN □			●	100nF	+80%~-20%	25	0.90
CL10○224KA8NNN □	●			220nF	±10%	25	0.90
CL10○224ZA8NNN □			●	220nF	+80%~-20%	25	0.90
CL10○334KA8NNN □	●			330nF	±10%	25	0.90
CL10○474ZA8NNN □			●	470nF	+80%~-20%	25	0.90
CL10○102KO8NNN □		●		1.0nF	±10%	16	0.90
CL10○103KO8NNN □		●		10nF	±10%	16	0.90
CL10○153KO8NNN □		●		15nF	±10%	16	0.90
CL10○223KO8NNN □		●		22nF	±10%	16	0.90
CL10○333KO8NNN □		●		33nF	±10%	16	0.90
CL10○473KO8NNN □		●		47nF	±10%	16	0.90
CL10○473ZO8NNN □			●	47nF	+80%~-20%	16	0.90
CL10○683KO8NNN □		●		68nF	±10%	16	0.90
CL10○104KO8NNN □		●		100nF	±10%	16	0.90
CL10○104ZO8NNN □			●	100nF	+80%~-20%	16	0.90
CL10○154KO8NNN □		●		150nF	±10%	16	0.90
CL10○224KO8NNN □		●		220nF	±10%	16	0.90
CL10○224ZO8NNN □			●	220nF	+80%~-20%	16	0.90
CL10○334KO8NNN □		●		330nF	±10%	16	0.90
CL10○474KO8NNN □		●		470nF	±10%	16	0.90
CL10○474ZO8NNN □			●	470nF	+80%~-20%	16	0.90
CL10○105ZO8NNN □			●	1.0μF	+80%~-20%	16	0.90
CL10○154KP8NNN □		●		150nF	±10%	10	0.90
CL10○224KP8NNN □	●	●		220nF	±10%	10	0.90
CL10○334KP8NNN □		●		330nF	±10%	10	0.90
CL10○474KP8NNN □		●		470nF	±10%	10	0.90
CL10○474ZP8NNN □			●	470nF	+80%~-20%	10	0.90
CL10○105ZP8NNN □			●	1.0μF	+80%~-20%	10	0.90
CL10○474KQ8NNN □		●		470nF	±10%	6.3	0.90
CL10○684KQ8NNN □		●		680nF	±10%	6.3	0.90
CL10○105KQ8NNN □		●		1.0μF	±10%	6.3	0.90

※ ○ mark means temperature characteristic code. The parts with mark ● are available to produce.

※ □ mark means packaging code. If you want to learn the code or quantity in detail, please see p 58.

Product Line UP (General Capacitors)

Part Number	Size L × W (2.0 × 1.25mm)			Capacitance	Capacitance Tolerance	Rated Voltage (Vdc)	Thickness max (mm)
	A	B	F				
	X5R(EIA)	X7R(EIA)	Y5V(EIA)				
CL21 ○ 151KBANNN □		●		0.15nF	±10%	50	0.75
CL21 ○ 221KBANNN □		●		0.22nF	±10%	50	0.75
CL21 ○ 331KBANNN □		●		0.33nF	±10%	50	0.75
CL21 ○ 471KBANNN □		●		0.47nF	±10%	50	0.75
CL21 ○ 681KBANNN □		●		0.68nF	±10%	50	0.75
CL21 ○ 102KBANNN □		●		1.0nF	±10%	50	0.75
CL21 ○ 152KBANNN □		●		1.5nF	±10%	50	0.75
CL21 ○ 222KBANNN □		●		2.2nF	±10%	50	0.75
CL21 ○ 332KBANNN □		●		3.3nF	±10%	50	0.75
CL21 ○ 332KBCNNN □		●		3.3nF	±10%	50	0.95
CL21 ○ 472KBANNN □		●		4.7nF	±10%	50	0.75
CL21 ○ 682KBANNN □		●		6.8nF	±10%	50	0.75
CL21 ○ 103KBANNN □		●		10nF	±10%	50	0.75
CL21 ○ 103KBCNNN □		●		10nF	±10%	50	0.95
CL21 ○ 103ZBANNN □			●	10nF	+80%~-20%	50	0.75
CL21 ○ 153KBANNN □		●		15nF	±10%	50	0.75
CL21 ○ 223KBANNN □		●		22nF	±10%	50	0.75
CL21 ○ 223ZBANNN □			●	22nF	+80%~-20%	50	0.75
CL21 ○ 333KBANNN □		●		33nF	±10%	50	0.75
CL21 ○ 473ZBANNN □			●	47nF	+80%~-20%	50	0.75
CL21 ○ 683KBCNNN □		●		68nF	±10%	50	0.95
CL21 ○ 104KBCNNN □		●		100nF	±10%	50	0.95
CL21 ○ 104ZBANNN □			●	100nF	+80%~-20%	50	0.75
CL21 ○ 104ZBCNNN □			●	100nF	+80%~-20%	50	0.95
CL21 ○ 154KBFNNN □		●		150nF	±10%	50	1.35
CL21 ○ 224KBFNNN □		●		220nF	±10%	50	1.35
CL21 ○ 224ZBCNNN □			●	220nF	+80%~-20%	50	0.95
CL21 ○ 474ZBFNNN □			●	470nF	+80%~-20%	50	1.35
CL21 ○ 105ZBFNNN □			●	1.0μF	+80%~-20%	50	1.35
CL21 ○ 102KAANNN □		●		1.0nF	±10%	25	0.75
CL21 ○ 103KAANNN □		●		10nF	±10%	25	0.75
CL21 ○ 473KAANNN □		●		47nF	±10%	25	0.75
CL21 ○ 683KAANNN □		●		68nF	±10%	25	0.75
CL21 ○ 104KACNNN □		●		100nF	±10%	25	0.95
CL21 ○ 104ZAANNN □			●	100nF	+80%~-20%	25	0.75

※ ○ mark means temperature characteristic code. The parts with mark ● are available to produce.

※ □ mark means packaging code. If you want to learn the code or quantity in detail, please see p 58.

Product Line UP (General Capacitors)

Part Number	Size L × W (2.0 × 1.25mm)			Capacitance	Capacitance Tolerance	Rated Voltage (Vdc)	Thickness max (mm)
	A	B	F				
	X5R(EIA)	X7R(EIA)	Y5V(EIA)				
CL21 ○ 154KAFNNN □		●		150nF	±10%	25	1.35
CL21 ○ 224KAFNNN □		●		220nF	±10%	25	1.35
CL21 ○ 224ZAANNN □			●	220nF	+80%~-20%	25	0.75
CL21 ○ 334KAFNNN □		●		330nF	±10%	25	1.35
CL21 ○ 474KAFNNN □		●		470nF	±10%	25	1.35
CL21 ○ 474ZACNNN □			●	470nF	+80%~-20%	25	0.95
CL21 ○ 105ZAFNNN □			●	1.0μF	+80%~-20%	25	1.35
CL21 ○ 225ZAFNNN □			●	2.2μF	+80%~-20%	25	1.35
CL21 ○ 153KOANNN □		●		15nF	±10%	16	0.75
CL21 ○ 333KOANNN □		●		33nF	±10%	16	0.75
CL21 ○ 104KOANNN □		●		100nF	±10%	16	0.75
CL21 ○ 104ZOANNN □			●	100nF	+80%~-20%	16	0.75
CL21 ○ 154KOANNN □		●		150nF	±10%	16	0.75
CL21 ○ 224KOCNNN □		●		220nF	±10%	16	0.95
CL21 ○ 224ZOANNN □			●	220nF	+80%~-20%	16	0.75
CL21 ○ 334KOCNNN □		●		330nF	±10%	16	0.95
CL21 ○ 474KOFNNN □		●		470nF	±10%	16	1.35
CL21 ○ 474ZOANNN □			●	470nF	+80%~-20%	16	0.75
CL21 ○ 474ZOCNNN □			●	470nF	+80%~-20%	16	0.95
CL21 ○ 684KOFNNN □		●		680nF	±10%	16	1.35
CL21 ○ 105KOFNNN □		●		1.0μF	±10%	16	1.35
CL21 ○ 105ZOCNNN □			●	1.0μF	+80%~-20%	16	0.95
CL21 ○ 105ZOFNNN □			●	1.0μF	+80%~-20%	16	1.35
CL21 ○ 225ZOFNNN □			●	2.2μF	+80%~-20%	16	1.35
CL21 ○ 475ZOFNNN □			●	4.7μF	+80%~-20%	16	1.35
CL21 ○ 474KPCNNN □		●		470nF	±10%	10	0.95
CL21 ○ 684KPFNNN □		●		680nF	±10%	10	1.35
CL21 ○ 105KPFNNN □		●		1.0μF	±10%	10	1.35
CL21 ○ 225ZPFNNN □			●	2.2μF	+80%~-20%	10	1.35
CL21 ○ 475ZPFNNN □			●	4.7μF	+80%~-20%	10	1.35

※ ○ mark means temperature characteristic code. The parts with mark ● are available to produce.

※ □ mark means packaging code. If you want to learn the code or quantity in detail, please see p 58.

Product Line UP (General Capacitors)

Part Number	Size L × W (3.2 × 1.6mm)			Capacitance	Capacitance Tolerance	Rated Voltage (Vdc)	Thickness max (mm)
	A	B	F				
	X5R(EIA)	X7R(EIA)	Y5V(EIA)				
CL31 ○ 154KBCNNN □		●		150nF	±10%	50	1.00
CL31 ○ 334KBFNNN □		●		330nF	±10%	50	1.40
CL31 ○ 474KBHNNN □		●		470nF	±10%	50	1.65
CL31 ○ 474ZBCNNN □			●	470nF	+80%~-20%	50	1.00
CL31 ○ 684KBHNNN □		●		680nF	±10%	50	1.65
CL31 ○ 105KBHNNN □		●		1.0μF	±10%	50	1.65
CL31 ○ 105ZBFNNN □			●	1.0μF	+80%~-20%	50	1.40
CL31 ○ 225KBHNNN □	●			2.2μF	±10%	50	1.65
CL31 ○ 104KACNNN □		●		100nF	±10%	25	1.00
CL31 ○ 154KACNNN □		●		150nF	±10%	25	1.00
CL31 ○ 224KACNNN □		●		220nF	±10%	25	1.00
CL31 ○ 334KACNNN □		●		330nF	±10%	25	1.00
CL31 ○ 684KAHNNN □		●		680nF	±10%	25	1.65
CL31 ○ 105KAHNNN □		●		1.0μF	±10%	25	1.65
CL31 ○ 105ZACNNN □			●	1.0μF	+80%~-20%	25	1.00
CL31 ○ 225KAHNNN □	●			2.2μF	±10%	25	1.65
CL31 ○ 225ZAFNNN □			●	2.2μF	+80%~-20%	25	1.40
CL31 ○ 334KOCNNN □		●		330nF	±10%	16	1.00
CL31 ○ 474KOCNNN □		●		470nF	±10%	16	1.00
CL31 ○ 684KOCNNN □		●		680nF	±10%	16	1.00
CL31 ○ 105ZOCNNN □			●	1.0μF	+80%~-20%	16	1.00
CL31 ○ 155KOFNNN □		●		1.5μF	±10%	16	1.40
CL31 ○ 225KOHNNN □		●		2.2μF	±10%	16	1.65
CL31 ○ 225ZOCNNN □			●	2.2μF	+80%~-20%	16	1.00
CL31 ○ 335KOC LNN □	●			3.3μF	±10%	16	1.00
CL31 ○ 335KOHNNN □	●	●		3.3μF	±10%	16	1.65
CL31 ○ 475ZOENNN □			●	4.7μF	+80%~-20%	16	1.25
CL31 ○ 475ZOFNNN □			●	4.7μF	+80%~-20%	16	1.40
CL31 ○ 106ZOHNNN □			●	10μF	+80%~-20%	16	1.65
CL31 ○ 105KPCNNN □		●		1.0μF	±10%	10	1.00
CL31 ○ 225KPENNN □		●		2.2μF	±10%	10	1.25
CL31 ○ 475KPHNNN □		●		4.7μF	±10%	10	1.65
CL31 ○ 106ZPENNN □			●	10μF	+80%~-20%	10	1.25
CL31 ○ 106ZPFNNN □			●	10μF	+80%~-20%	10	1.40
CL31 ○ 685KQHNNN □		●		6.8μF	±10%	6.3	1.65
CL31 ○ 106KQHNNN □		●		10μF	±10%	6.3	1.65

※ ○ mark means temperature characteristic code. The parts with mark ● are available to produce.
 ※ □ mark means packaging code. If you want to learn the code or quantity in detail, please see p 58.

Product Line UP (General Capacitors)

Part Number	Size L × W (3.2 × 2.5mm)			Capacitance	Capacitance Tolerance	Rated Voltage (Vdc)	Thickness max (mm)
	A	B	F				
	X5R(EIA)	X7R(EIA)	Y5V(EIA)				
CL32 ○ 474KBFNNN □		●		470nF	±10%	50	1.45
CL32 ○ 225KBJNNN □		●		2.2μF	±10%	50	2.70
CL32 ○ 475KLULNN □	●			4.7μF	±10%	35	2.00
CL32 ○ 106KLULNN □	●			10μF	±10%	35	2.00
CL32 ○ 106ZLHNNN □			●	10μF	+80%~-20%	35	1.80
CL32 ○ 105KAFNNN □		●		1.0μF	±10%	25	1.45
CL32 ○ 475KAULNN □	●			4.7μF	±10%	25	2.00
CL32 ○ 475KAJNNN □	●			4.7μF	±10%	25	2.20
CL32 ○ 475ZAHNNN □			●	4.7μF	+80%~-20%	25	1.80
CL32 ○ 106KA9LNN □	●			10μF	±10%	25	1.00
CL32 ○ 106KATLNN □	●			10μF	±10%	25	1.70
CL32 ○ 106KAULNN □	●			10μF	±10%	25	2.00
CL32 ○ 106KAJNNN □		●		10μF	±10%	25	2.70
CL32 ○ 106KAJSNN □		●		10μF	±10%	25	2.70
CL32 ○ 106ZAHNNN □			●	10μF	+80%~-20%	25	1.80
CL32 ○ 106ZASLNN □			●	10μF	+80%~-20%	25	1.50
CL32 ○ 475KOJNNN □		●		4.7μF	±10%	16	2.20
CL32 ○ 475ZO9LNN □			●	4.7μF	+80%~-20%	16	1.00
CL32 ○ 475ZOFNNN □			●	4.7μF	+80%~-20%	16	1.45
CL32 ○ 106KOC LNN □	●			10μF	±10%	16	0.95
CL32 ○ 106KO9LNN □	●			10μF	±10%	16	1.00
CL32 ○ 106KOMLNN □	●			10μF	±10%	16	1.25
CL32 ○ 106KOTLNN □	●			10μF	±10%	16	1.70
CL32 ○ 106KOJNNN □	●	●		10μF	±10%	16	2.70
CL32 ○ 106ZOE LNN □			●	10μF	+80%~-20%	16	1.20
CL32 ○ 106ZOHNNN □			●	10μF	+80%~-20%	16	1.80
CL32 ○ 106ZOMLNN □			●	10μF	+80%~-20%	16	1.25
CL32 ○ 106KPI NNN □	●	●		10μF	±10%	10	2.20

Part Number	Size L × W (4.5 × 3.2mm)			Capacitance	Capacitance Tolerance	Rated Voltage (Vdc)	Thickness max (mm)
	A	B	F				
	X5R(EIA)	X7R(EIA)	Y5V(EIA)				
CL43 ○ 684KBFNNN □		●		680nF	±10%	50	1.45
CL43 ○ 105KBFNNN □		●		1μF	±10%	50	1.45
CL43 ○ 106KALNNN □		●		10μF	±10%	25	3.40

Part Number	Size L × W (5.7 × 5.0mm)			Capacitance	Capacitance Tolerance	Rated Voltage (Vdc)	Thickness max (mm)
	A	B	F				
	X5R(EIA)	X7R(EIA)	Y5V(EIA)				
CL55 ○ 105KBINNN □		●		1μF	±10%	50	2.20
CL55 ○ 476KPJNNN □	●			47μF	±10%	10	2.70
CL55 ○ 107KQJNNN □	●			100μF	±10%	6.3	2.70
CL55 ○ 107ZPJNNN □			●	100μF	+80%~-20%	10	2.70

※ ○ mark means temperature characteristic code. The parts with mark ● are available to produce.
 ※ □ mark means packaging code. If you want to learn the code or quantity in detail, please see p 58.

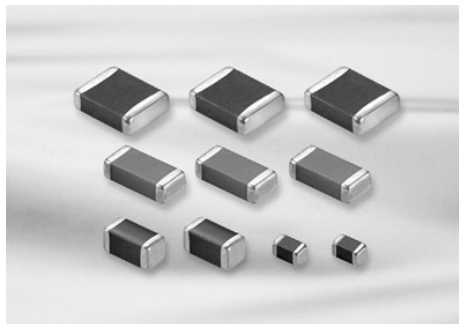

Feature

- Wide selection of size : from 0402 to 1812
- Highly reliable tolerance and high speed automatic chip placement on PCBs
- Wide capacitance range
- Highly reliable performance
- Highly resistant termination metal
- Tape & reel for surface mount assembly

Application

- Desktop PC, Note PC, HHP, DC-DC Converter, DSC
- LCD TV, LCD Monitor

Structure and Dimensions

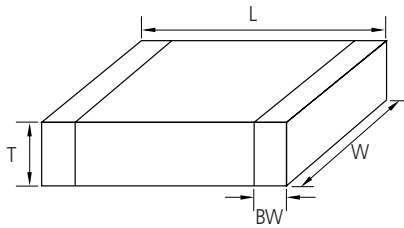

Code	EIA Code	Dimension (mm)			
		L	W	T	BW
05	0402	1.0±0.05	0.5±0.05	0.5±0.05	0.2+0.15/-0.1
10	0603	1.6±0.1	0.8±0.1	0.8±0.1	0.3±0.2
21	0805	2.0±0.1	1.25±0.1	1.25±0.1	0.5+0.2/-0.3
		2.0±0.15	1.25±0.15	1.25±0.15	0.5+0.2/-0.3
31	1206	3.2±0.2	1.6±0.2	1.6±0.2	0.5±0.3
		3.2±0.15	1.6±0.15	0.85±0.15	
32	1210	3.2±0.3	2.5±0.2	2.5±0.2	0.6±0.3
		3.2±0.4	2.5±0.3	2.5±0.3	0.6±0.3
42	1808	4.5±0.4	2.0±0.2	2.0±0.2	0.8±0.3
43	1812	4.5±0.4	3.2±0.3	3.2±0.3	0.8±0.3

Capacitance Table (Ultra High Capacitors)

Size	0402(05)			0603(10)				
	X5R(A)							
TC	4(R)	6.3(Q)	10(P)	4(R)	6.3(Q)	10(P)	16(O)	25(A)
Rated V	4(R)	6.3(Q)	10(P)	4(R)	6.3(Q)	10(P)	16(O)	25(A)
Capacitance -nF- (part numbering code) and thickness -mm-								
0.10(101)								
0.15(151)								
0.22(221)								
0.33(331)								
0.47(471)								
0.68(681)								
1.0(102)								
1.5(152)								
2.2(222)								
3.3(332)								
4.7(472)								
6.8(682)								
10(103)								
15(153)								
22(223)								
33(333)								
47(473)								
68(683)								
100(104)								
150(154)								
220(224)			0.5 (5)					
330(334)								
470(474)								
680(684)			0.5 (5)					
1000(105)						0.8 (8)		
1500(155)								
2200(225)	0.5 (5)						0.8 (8)	
3300(335)								
4700(475)						0.8 (8)		
10000(106)						0.8 (8)		

Legend: :X7R(B) :X5R(A) :Y5V(F) :C0G(C) :X6S(X)

Capacitance Table (Ultra High Capacitors)

Size	0805(21)					1206(31)				1210(32)			1812(43)	
TC	X5R(A)													
Rated V	4(R)	6.3(Q)	10(P)	16(O)	25(A)	6.3(Q)	10(P)	16(O)	25(A)	6.3(Q)	10(P)	16(O)	6.3(Q)	
Capacitance -nF- (part numbering code) and thickness -mm-														
0.15(151)														
0.22(221)														
0.33(331)														
0.47(471)														
0.68(681)														
1.0(102)														
1.5(152)														
2.2(222)														
3.3(332)														
4.7(472)														
6.8(682)														
10(103)														
15(153)														
22(223)														
33(333)														
47(473)														
68(683)														
100(104)														
150(154)														
220(224)														
330(334)														
390(394)														
470(474)														
680(684)														
1000(105)														
1500(155)														
2200(225)														
3300(335)														
4700(475)														
6800(685)														
10000(106)														
15000(156)														
22000(226)														
47000(476)														
68000(686)														
100000(107)														

Capacitance Table (Ultra High Capacitors)

Size	0402(05)	0603(10)	0805(21)			1206(31)	1210(32)	1812(43)
TC	X7R(B) / X6S(X)							
Rated V	6.3(Q)	6.3(Q)	4(R)	6.3(Q)	10(P)	6.3(Q)	6.3(Q)	10(P)
Capacitance -nF- (part numbering code) and thickness -mm-								
2.2(222)								
4.7(472)								
10(103)								
22(223)								
47(473)								
100(104)								
220(224)								
470(474)								
1000(105)								
2200(225)								
4700(475)								
10000(106)								
22000(226)								
47000(476)								
100000(107)								

Size	0402(05)	0603(10)		0805(21)	1206(31)	1210(32)	
TC	Y5V(F)						
Rated V	6.3(Q)	6.3(Q)	10(P)	10(P)	10(P)	6.3(Q)	10(P)
Capacitance -nF- (part numbering code) and thickness -mm-							
2.2(222)							
4.7(472)							
10(103)							
22(223)							
47(473)							
100(104)							
220(224)							
470(474)							
1000(105)							
2200(225)							
4700(475)							
10000(106)							
22000(226)							
47000(476)							
100000(107)							

Product Line UP (Ultra High Capacitors)

Part Number	TC Code	Temperature Characteristics	Size L × W (mm)	Capacitance	Capacitance Tolerance	Rated Voltage (Vdc)	Thickness max (mm)
CL10A474KA8NNN □	X5R(EIA)	± 15%(-55~+85℃)	1.60 × 0.80	0.47 μF	± 10%	25	0.90
CL10A105KA8NNN □	X5R(EIA)	± 15%(-55~+85℃)	1.60 × 0.80	1.0 μF	± 10%	25	0.90
CL21A105KACLNN □	X5R(EIA)	± 15%(-55~+85℃)	2.00 × 1.25	1.0 μF	± 10%	25	1.00
CL21A105KAFNNN □	X5R(EIA)	± 15%(-55~+85℃)	2.00 × 1.25	1.0 μF	± 10%	25	1.35
CL21A225KAFNNN □	X5R(EIA)	± 15%(-55~+85℃)	2.00 × 1.25	2.2 μF	± 10%	25	1.35
CL31A475KACLNN □	X5R(EIA)	± 15%(-55~+85℃)	3.20 × 1.60	4.7 μF	± 10%	25	1.00
CL31A475KAPLNN □	X5R(EIA)	± 15%(-55~+85℃)	3.20 × 1.60	4.7 μF	± 10%	25	1.25
CL31A475KAHNNN □	X5R(EIA)	± 15%(-55~+85℃)	3.20 × 1.60	4.7 μF	± 10%	25	1.80
CL31A106KAHNNN □	X5R(EIA)	± 15%(-55~+85℃)	3.20 × 1.60	10 μF	± 10%	25	1.80
CL10A105K05LNN □	X5R(EIA)	± 15%(-55~+85℃)	1.60 × 0.80	1.0 μF	± 10%	16	0.55
CL10A105K08NNN □	X5R(EIA)	± 15%(-55~+85℃)	1.60 × 0.80	1.0 μF	± 10%	16	0.90
CL21A105K06LNN □	X5R(EIA)	± 15%(-55~+85℃)	2.00 × 1.25	1.0 μF	± 10%	16	0.70
CL21A105K0FNNN □	X5R(EIA)	± 15%(-55~+85℃)	2.00 × 1.25	1.0 μF	± 10%	16	1.35
CL10A225K08NNN □	X5R(EIA)	± 15%(-55~+85℃)	1.60 × 0.80	2.2 μF	± 10%	16	0.90
CL21A225K0FNNN □	X5R(EIA)	± 15%(-55~+85℃)	2.00 × 1.25	2.2 μF	± 10%	16	1.35
CL21A475K0FNNN □	X5R(EIA)	± 15%(-55~+85℃)	2.00 × 1.25	4.7 μF	± 10%	16	1.35
CL31A475K0CLNN □	X5R(EIA)	± 15%(-55~+85℃)	3.20 × 1.60	4.7 μF	± 10%	16	1.00
CL31A475K0HNNN □	X5R(EIA)	± 15%(-55~+85℃)	3.20 × 1.60	4.7 μF	± 10%	16	1.80
CL31A106K0CLNN □	X5R(EIA)	± 15%(-55~+85℃)	3.20 × 1.60	10 μF	± 10%	16	1.00
CL31A106K0HNNN □	X5R(EIA)	± 15%(-55~+85℃)	3.20 × 1.60	10 μF	± 10%	16	1.80
CL32A226K0JNNN □	X5R(EIA)	± 15%(-55~+85℃)	3.20 × 2.50	22 μF	± 10%	16	2.80
CL10A474K08NNN □	X5R(EIA)	± 15%(-55~+85℃)	1.60 × 0.80	0.47 μF	± 10%	16	0.90
CL05A224KP5NNN □	X5R(EIA)	± 15%(-55~+85℃)	1.00 × 0.50	0.22 μF	± 10%	10	0.55
CL10A684KP8NNN □	X5R(EIA)	± 15%(-55~+85℃)	1.60 × 0.80	0.68 μF	± 10%	10	0.90
CL21A105KPFNNN □	X5R(EIA)	± 15%(-55~+85℃)	2.00 × 1.25	1.0 μF	± 10%	10	1.35
CL10A225KP8NNN □	X5R(EIA)	± 15%(-55~+85℃)	1.60 × 0.80	2.2 μF	± 10%	10	0.90
CL21A225KPENNN □	X5R(EIA)	± 15%(-55~+85℃)	2.00 × 1.25	2.2 μF	± 10%	10	1.20
CL21A225KPFNNN □	X5R(EIA)	± 15%(-55~+85℃)	2.00 × 1.25	2.2 μF	± 10%	10	1.35
CL21A475KPCLNN □	X5R(EIA)	± 15%(-55~+85℃)	2.00 × 1.25	4.7 μF	± 10%	10	1.00
CL21A475KPFNNN □	X5R(EIA)	± 15%(-55~+85℃)	2.00 × 1.25	4.7 μF	± 10%	10	1.35
CL31A475KP6LNN □	X5R(EIA)	± 15%(-55~+85℃)	3.20 × 1.60	4.7 μF	± 10%	10	0.70
CL21A106KPFNNN □	X5R(EIA)	± 15%(-55~+85℃)	2.00 × 1.25	10 μF	± 10%	10	1.35
CL31A106KPPLNN □	X5R(EIA)	± 15%(-55~+85℃)	3.20 × 1.60	10 μF	± 10%	10	1.25
CL31A106KPHNNN □	X5R(EIA)	± 15%(-55~+85℃)	3.20 × 1.60	10 μF	± 10%	10	1.80
CL31A226KPHNNN □	X5R(EIA)	± 15%(-55~+85℃)	3.20 × 1.60	22 μF	± 10%	10	1.80

※ □ mark means packaging code. If you want to learn the code or quantity in detail, please see p 58.

Product Line UP (Ultra High Capacitors)

Part Number	TC Code	Temperature Characteristics	Size L × W (mm)	Capacitance	Capacitance Tolerance	Rated Voltage (Vdc)	Thickness max (mm)
CL32A226KPJNNN □	X5R(EIA)	± 15%(-55~+85℃)	3.20 × 2.50	22 μF	± 10%	10	2.80
CL05A224KQ5NNN □	X5R(EIA)	± 15%(-55~+85℃)	1.00 × 0.50	0.22 μF	± 10%	6.3	0.55
CL05A334KQ5NNN □	X5R(EIA)	± 15%(-55~+85℃)	1.00 × 0.50	0.33 μF	± 10%	6.3	0.55
CL05A474KQ5NNN □	X5R(EIA)	± 15%(-55~+85℃)	1.00 × 0.50	0.47 μF	± 10%	6.3	0.55
CL05A105KQ5NNN □	X5R(EIA)	± 15%(-55~+85℃)	1.00 × 0.50	1.0 μF	± 10%	6.3	0.55
CL05A225KQ5NSN □	X5R(EIA)	± 15%(-55~+85℃)	1.00 × 0.50	2.2 μF	± 10%	6.3	0.57
CL10A225KQ5LNN □	X5R(EIA)	± 15%(-55~+85℃)	1.60 × 0.80	2.2 μF	± 10%	6.3	0.55
CL10A225KQ8NNN □	X5R(EIA)	± 15%(-55~+85℃)	1.60 × 0.80	2.2 μF	± 10%	6.3	0.90
CL10A335KQ8NNN □	X5R(EIA)	± 15%(-55~+85℃)	1.60 × 0.80	3.3 μF	± 10%	6.3	0.90
CL21A335KQFNNN □	X5R(EIA)	± 15%(-55~+85℃)	2.00 × 1.25	3.3 μF	± 10%	6.3	1.35
CL10A475KQ8NNN □	X5R(EIA)	± 15%(-55~+85℃)	1.60 × 0.80	4.7 μF	± 10%	6.3	0.90
CL21A475KQCLNN □	X5R(EIA)	± 15%(-55~+85℃)	2.00 × 1.25	4.7 μF	± 10%	6.3	1.00
CL21A475KQFNNN □	X5R(EIA)	± 15%(-55~+85℃)	2.00 × 1.25	4.7 μF	± 10%	6.3	1.35
CL10A106KQ8NNN □	X5R(EIA)	± 15%(-55~+85℃)	1.60 × 0.80	10 μF	± 10%	6.3	0.90
CL21A106KQCLNN □	X5R(EIA)	± 15%(-55~+85℃)	2.00 × 1.25	10 μF	± 10%	6.3	1.00
CL21A106KQFNNN □	X5R(EIA)	± 15%(-55~+85℃)	2.00 × 1.25	10 μF	± 10%	6.3	1.35
CL31A106KQHNNN □	X5R(EIA)	± 15%(-55~+85℃)	3.20 × 1.60	10 μF	± 10%	6.3	1.80
CL31A156KQHNNN □	X5R(EIA)	± 15%(-55~+85℃)	3.20 × 1.60	15 μF	± 10%	6.3	1.80
CL21A226MQQNNN □	X5R(EIA)	± 15%(-55~+85℃)	2.00 × 1.25	22 μF	± 20%	6.3	1.35
CL31A226KQHNNN □	X5R(EIA)	± 15%(-55~+85℃)	3.20 × 1.60	22 μF	± 10%	6.3	1.80
CL32A226MQCLNN □	X5R(EIA)	± 15%(-55~+85℃)	3.20 × 2.50	22 μF	± 20%	6.3	1.00
CL32A226KQJNNN □	X5R(EIA)	± 15%(-55~+85℃)	3.20 × 2.50	22 μF	± 10%	6.3	2.80
CL31A476MQHNNN □	X5R(EIA)	± 15%(-55~+85℃)	3.20 × 1.60	47 μF	± 20%	6.3	1.80
CL32A476MQJNNN □	X5R(EIA)	± 15%(-55~+85℃)	3.20 × 2.50	47 μF	± 20%	6.3	2.80
CL43A476MQJNNN □	X5R(EIA)	± 15%(-55~+85℃)	4.50 × 3.20	47 μF	± 20%	6.3	2.80
CL32A107MQVNNN □	X5R(EIA)	± 15%(-55~+85℃)	3.20 × 2.50	100 μF	± 20%	6.3	2.80
CL43A107MQLNNN □	X5R(EIA)	± 15%(-55~+85℃)	4.50 × 3.20	100 μF	± 20%	6.3	3.50
CL05A225KR5NNN □	X5R(EIA)	± 15%(-55~+85℃)	1.00 × 0.50	2.2 μF	± 10%	4	0.55
CL10A106KR8NNN □	X5R(EIA)	± 15%(-55~+85℃)	1.60 × 0.80	10 μF	± 10%	4	0.90
CL21A476MRQNHN □	X5R(EIA)	± 15%(-55~+85℃)	2.00 × 1.25	47 μF	± 20%	4	1.35

※ □ mark means packaging code. If you want to learn the code or quantity in detail, please see p 58.

Product Line UP (Ultra High Capacitors)

Part Number	TC Code	Temperature Characteristics	Size L × W (mm)	Capacitance	Capacitance Tolerance	Rated Voltage (Vdc)	Thickness max (mm)
CL05X105KQ5N [□]	X6S(EIA)	±22%(-55~+105℃)	1.00 × 0.50	1.0μF	±10%	6.3	0.55
CL10X105KQ8N [□]	X6S(EIA)	±22%(-55~+105℃)	1.60 × 0.80	1.0μF	±10%	6.3	0.90
CL21X225KQFN [□]	X6S(EIA)	±22%(-55~+105℃)	2.00 × 1.25	2.2μF	±10%	6.3	1.35
CL21X475KQFN [□]	X6S(EIA)	±22%(-55~+105℃)	2.00 × 1.25	4.7μF	±10%	6.3	1.35
CL31X106KQH [□]	X6S(EIA)	±22%(-55~+105℃)	3.20 × 1.60	10μF	±10%	6.3	1.80
CL21X106KRFN [□]	X6S(EIA)	±22%(-55~+105℃)	2.00 × 1.25	10μF	±10%	4	1.35
CL21B225KPFN [□]	X7R(EIA)	±15%(-55~+125℃)	2.00 × 1.25	2.2μF	±10%	10	1.35
CL43B226KQJN [□]	X7R(EIA)	±15%(-55~+125℃)	4.50 × 3.20	22μF	±10%	10	2.80
CL21B225KPFN [□]	X7R(EIA)	±15%(-55~+125℃)	2.00 × 1.25	2.2μF	±10%	6.3	1.35
CL31B106KQH [□]	X7R(EIA)	±15%(-55~+125℃)	3.20 × 1.60	10μF	±10%	6.3	1.80
CL32B226KQJN [□]	X7R(EIA)	±15%(-55~+125℃)	3.20 × 2.50	22μF	±10%	6.3	2.80

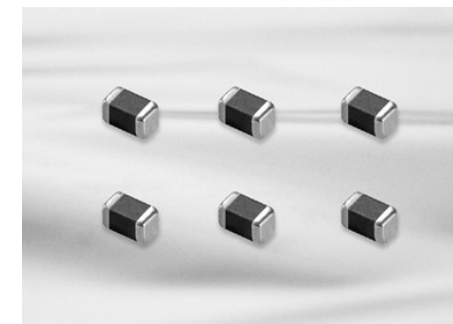

Feature

- Small chip size(0.6×0.3×0.3 mm)
- 03 Series(COG) MLCC shows very low ESR value.
- 03 Series are suited to only reflow soldering
- 03 Series are suited to miniature RF module, portable equipment and high frequency circuit

Application

- VCO, Tuner, RF Module
- MCM Module
- Mobile phone, Wireless LAN, Note PC

Structure and Dimensions

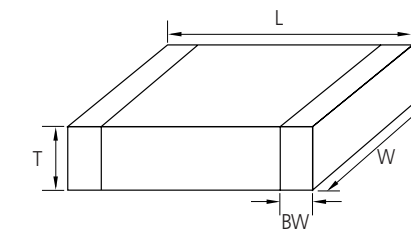

Part Number	TC Code	Temperature Characteristics	Size L × W (mm)	Capacitance	Capacitance Tolerance	Rated Voltage (Vdc)	Thickness max (mm)
CL10F225ZP8N [□]	Y5V(EIA)	-82~+22%(-30~+85℃)	1.60 × 0.80	2.2μF	80% / -20%	10	0.90
CL21F106ZPFN [□]	Y5V(EIA)	-82~+22%(-30~+85℃)	2.00 × 1.25	10μF	80% / -20%	10	1.35
CL31F226ZPHN [□]	Y5V(EIA)	-82~+22%(-30~+85℃)	3.20 × 1.60	22μF	80% / -20%	10	1.80
CL32F226ZPIN [□]	Y5V(EIA)	-82~+22%(-30~+85℃)	3.20 × 2.50	22μF	80% / -20%	10	2.20
CL32F226ZPJN [□]	Y5V(EIA)	-82~+22%(-30~+85℃)	3.20 × 2.50	22μF	80% / -20%	10	2.80
CL05F105ZQ5N [□]	Y5V(EIA)	-82~+22%(-30~+85℃)	1.00 × 0.50	1.0μF	80% / -20%	6.3	0.55
CL10F475ZQ8N [□]	Y5V(EIA)	-82~+22%(-30~+85℃)	1.60 × 0.80	4.7μF	80% / -20%	6.3	0.90
CL32F107ZQJN [□]	Y5V(EIA)	-82~+22%(-30~+85℃)	3.20 × 2.50	100μF	80% / -20%	6.3	2.80

※ □ mark means packaging code. If you want to learn the code or quantity in detail, please see p 58.

Code	EIA Code	Dimension(mm)			
		L	W	T	BW
03	0201	0.6±0.03	0.3±0.03	0.3±0.03	0.15±0.05

Capacitance Table (Super Small Size Capacitors)

Size	0201(03)						Y5V(F) 6.3(Q)
	COG(C)		X7R(B) / X5R(A)			Y5V(F) 6.3(Q)	
	25(A)	50(B)	6.3(Q)	10(P)	16(O)		
Capacitance -pF- (part numbering code) and thickness -mm- (part numbering code)							
0.5(0R5)							
0.75(R75)							
1.0(010)							
2.0(020)							
3.0(030)							
4.0(040)							
5.0(050)							
6.0(060)							
7.0(070)							
8.0(080)							
9.0(090)							
10(100)							
12(120)							
15(150)							
18(180)							
20(200)							
22(220)							
27(270)							
33(330)							
39(390)							
47(470)							
56(560)							
68(680)							
82(820)							
100(101)							
150(151)							
220(221)							
330(331)							
470(471)							
680(681)							
1000(102)							
1500(152)							
2200(222)							
3300(332)							
4700(472)							
6800(682)							
10000(103)							
15000(153)							
22000(223)							
33000(333)							
47000(473)							
68000(683)							
100000(104)							

Legend: :X7R(B) :X5R(A) :Y5V(F) :COG(C) :X6S(X)

Product Line UP (Super Small Size Capacitors)

Part Number	TC Code	Temperature Characteristics	Size L × W (mm)	Capacitance	Capacitance Tolerance	Rated Voltage (Vdc)	Thickness max (mm)	Remark
CL03C0R5CA3GNN □	COG(EIA)	±30ppm/°C (-55~+125°C)	0.60 × 0.30	0.5pF	±0.25pF	25	0.33	High-Q
CL03C010CA3GNN □	COG(EIA)	±30ppm/°C (-55~+125°C)	0.60 × 0.30	1.0pF	±0.25pF	25	0.33	High-Q
CL03C1R2CA3GNN □	COG(EIA)	±30ppm/°C (-55~+125°C)	0.60 × 0.30	1.2pF	±0.25pF	25	0.33	High-Q
CL03C1R5CA3GNN □	COG(EIA)	±30ppm/°C (-55~+125°C)	0.60 × 0.30	1.5pF	±0.25pF	25	0.33	High-Q
CL03C1R8CA3GNN □	COG(EIA)	±30ppm/°C (-55~+125°C)	0.60 × 0.30	1.8pF	±0.25pF	25	0.33	High-Q
CL03C020CA3GNN □	COG(EIA)	±30ppm/°C (-55~+125°C)	0.60 × 0.30	2.0pF	±0.25pF	25	0.33	High-Q
CL03C2R2CA3GNN □	COG(EIA)	±30ppm/°C (-55~+125°C)	0.60 × 0.30	2.2pF	±0.25pF	25	0.33	High-Q
CL03C2R7CA3GNN □	COG(EIA)	±30ppm/°C (-55~+125°C)	0.60 × 0.30	2.7pF	±0.25pF	25	0.33	High-Q
CL03C030CA3GNN □	COG(EIA)	±30ppm/°C (-55~+125°C)	0.60 × 0.30	3.0pF	±0.25pF	25	0.33	High-Q
CL03C3R3CA3GNN □	COG(EIA)	±30ppm/°C (-55~+125°C)	0.60 × 0.30	3.3pF	±0.25pF	25	0.33	High-Q
CL03C3R9CA3GNN □	COG(EIA)	±30ppm/°C (-55~+125°C)	0.60 × 0.30	3.9pF	±0.25pF	25	0.33	High-Q
CL03C4R7CA3GNN □	COG(EIA)	±30ppm/°C (-55~+125°C)	0.60 × 0.30	4.7pF	±0.25pF	25	0.33	High-Q
CL03C5R6DA3GNN □	COG(EIA)	±30ppm/°C (-55~+125°C)	0.60 × 0.30	5.6pF	±0.5pF	25	0.33	High-Q
CL03C6R8DA3GNN □	COG(EIA)	±30ppm/°C (-55~+125°C)	0.60 × 0.30	6.8pF	±0.5pF	25	0.33	High-Q
CL03C8R2DA3GNN □	COG(EIA)	±30ppm/°C (-55~+125°C)	0.60 × 0.30	8.2pF	±0.5pF	25	0.33	High-Q
CL03C090DA3GNN □	COG(EIA)	±30ppm/°C (-55~+125°C)	0.60 × 0.30	9.0pF	±0.5pF	25	0.33	High-Q
CL03C100JA3GNN □	COG(EIA)	±30ppm/°C (-55~+125°C)	0.60 × 0.30	10pF	±5%	25	0.33	High-Q
CL03C150JA3GNN □	COG(EIA)	±30ppm/°C (-55~+125°C)	0.60 × 0.30	15pF	±5%	25	0.33	High-Q
CL03C180JA3GNN □	COG(EIA)	±30ppm/°C (-55~+125°C)	0.60 × 0.30	18pF	±5%	25	0.33	High-Q
CL03C220JA3GNN □	COG(EIA)	±30ppm/°C (-55~+125°C)	0.60 × 0.30	22pF	±5%	25	0.33	High-Q
CL03C270JA3GNN □	COG(EIA)	±30ppm/°C (-55~+125°C)	0.60 × 0.30	27pF	±5%	25	0.33	High-Q
CL03C330JA3GNN □	COG(EIA)	±30ppm/°C (-55~+125°C)	0.60 × 0.30	33pF	±5%	25	0.33	High-Q
CL03C390JA3ANN □	COG(EIA)	±30ppm/°C (-55~+125°C)	0.60 × 0.30	39pF	±5%	25	0.33	
CL03C470JA3ANN □	COG(EIA)	±30ppm/°C (-55~+125°C)	0.60 × 0.30	47pF	±5%	25	0.33	
CL03C101JA3ANN □	COG(EIA)	±30ppm/°C (-55~+125°C)	0.60 × 0.30	100pF	±5%	25	0.33	

※ □ mark means packaging code. If you want to learn the code or quantity in detail, please see p 58.

Product Line UP (Super Small Size Capacitors)

Part Number	TC Code	Temperature Characteristics	Size L × W (mm)	Capacitance	Capacitance Tolerance	Rated Voltage (Vdc)	Thickness max (mm)
CL03B331KA3NNN □	X7R(EIA)	±15%(-55~+125℃)	0.60 × 0.30	0.33nF	±10%	25	0.33
CL03B102KA3NNN □	X7R(EIA)	±15%(-55~+125℃)	0.60 × 0.30	1.0nF	±10%	25	0.33
CL03B331KO3NNN □	X7R(EIA)	±15%(-55~+125℃)	0.60 × 0.30	0.33nF	±10%	16	0.33
CL03B472KP3NNN □	X7R(EIA)	±15%(-55~+125℃)	0.60 × 0.30	4.7nF	±10%	10	0.33
CL03A103KP3NNN □	X5R(EIA)	±15%(-55~+85℃)	0.60 × 0.30	10nF	±10%	10	0.33
CL03B103KP3NNN □	X7R(EIA)	±15%(-55~+125℃)	0.60 × 0.30	10nF	±10%	10	0.33
CL03B472KQ3NNN □	X7R(EIA)	±15%(-55~+125℃)	0.60 × 0.30	4.7nF	±10%	6.3	0.33
CL03A223KQ3NNN □	X5R(EIA)	±15%(-55~+85℃)	0.60 × 0.30	22nF	±10%	6.3	0.33
CL03A473KQ3NNN □	X5R(EIA)	±15%(-55~+85℃)	0.60 × 0.30	47nF	±10%	6.3	0.33
CL03A104KQ3NNN □	X5R(EIA)	±15%(-55~+85℃)	0.60 × 0.30	100nF	±10%	6.3	0.33

※ □ mark means packaging code. If you want to learn the code or quantity in detail, please see p 58.

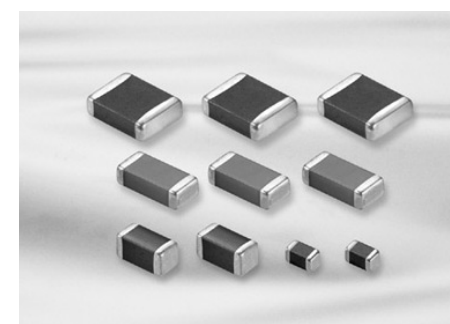

Feature

- Highly reliable performance
- Operating at high voltage level
- Wide voltage level: from 100V to 3000V
- High withstanding voltage
- Tape & reel surface mount assembly

Application

- Switching Power Circuit(SMPS)
- Lighting Ballast, LCD back lighting inverter
- DC-DC converter input filter, snubber circuit
- Tip & Ring(Phone, Fax, Modem)
- Network(IEEE802.3)

Structure and Dimensions

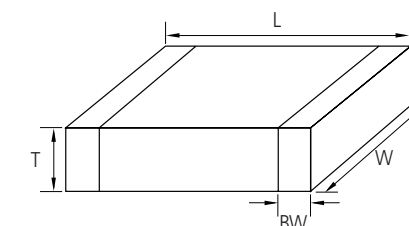

Code	EIA Code	Dimension(㎜)			
		L	W	T	BW
10	0603	1.6±0.1	0.8±0.1	0.8±0.1	0.3±0.2
21	0805	2.0±0.1	1.25±0.1	1.25±0.1	0.5+0.2/-0.3
31	1206	3.2±0.2	1.6±0.2	1.6±0.2	0.5±0.3
		3.2±0.15	1.6±0.15	0.85±0.15	
32	1210	3.2±0.3	2.5±0.2	2.5±0.2	0.6±0.3
42	1808	4.5±0.4	2.0±0.2	2.0±0.2	0.8±0.3
43	1812	4.5±0.4	3.2±0.3	3.2±0.3	0.8±0.3
55	2220	5.7±0.4	5.0±0.4	3.2±0.3	1.0±0.3

Capacitance Table (High Voltage Capacitors)

Size	0603(10)		0805(21)			1206(31)			
	TC								
Rated V	COG(C)								
	250(E)	100(C)	200(D)	250(E)	100(C)	250(E)	630(H)	1000(I)	2000(J)
Capacitance -pF- (part numbering code) and thickness -mm-									
0.5(0R5) ~9.1(9R1)									
10(100) ~27(270)									
33(330)									1.6 (H)
39(390)									
47(470)	0.80 (8)	0.65 (A)						1.25 (F)	
56(560)									
68(680)									
82(820) ~180(181)									
220(221) ~390(391)								1.6 (H)	150 270
470(471)							1.25 (F)		
560(561)									
680(681)		0.85 (C)			1.25 (F)		0.85 (C)		
820(821)			1.25 (F)				1.25 (F)		
1000(102)									
1200(122)						0.85 (C)			
1500(152)							1.6 (H)		
1800(182)									
2200(222)									
2700(272)									
3300(332)						1.25 (F)			
3900(392)									
4700(472)									
5600(562)									
6800(682)									

Legend: :X7R(B) :X5R(A) :Y5V(F) :COG(C) :X6S(X)

Capacitance Table (High Voltage Capacitors)

Size	1210(32)						1808(42)
	TC						
Rated V	COG(C)						
	100(C)	200(D)	250(E)	630(H)	1000(I)	2000(J)	3000(K)
Capacitance -pF- (part numbering code) and thickness -mm-							
10(100)							
12(120)							
15(150)							
18(180)							
22(220)							
27(270)							
33(330)							
39(390)							
47(470)							
56(560)							
68(680)							
82(820)						1.25 (F)	
100(101)							
120(121)							
150(151)							
180(181)							
220(221)							
270(271)							
330(331)							
390(391)							
470(471)					1.25 (F)		
560(561)							
680(681)							
820(821)							
1000(102)							
1200(122)							
1500(152)							
2200(222)							
2700(272)							
3300(332)							
3900(392)							
4700(472)							
5600(562)							
6800(682)							
8200(822)							
10000(103)							
12000(123)							
15000(153)							
18000(183)							

Legend: :X7R(B) :X5R(A) :Y5V(F) :COG(C) :X6S(X)

Capacitance Table (High Voltage Capacitors)

Size	1812(43)							2220(55)				
	COG(C)							250(E)	630(H)	1000(I)	3000(K)	
TC	X7R(B)											
Rated V	100(C)	200(D)	250(E)	500(G)	630(H)	1000(I)	2000(J)	3000(K)	250(E)	630(H)	1000(I)	3000(K)
Capacitance -pF- (part numbering code) and thickness -mm-												
47(470)							1.25 (F)					
82(820)												
100(101)												
120(121)												
150(151)												
180(181)												
220(221)												
270(271)												
390(391)												
470(471)												
680(681)												
820(821)												
1000(102)												
1200(122)												
1500(152)												
1800(182)												
2200(222)												
2700(272)												
3300(332)												
4700(472)												
5600(562)												
6800(682)												
8200(822)												
10000(103)												
12000(123)												
15000(153)												
18000(183)												
22000(223)												
27000(273)												
33000(333)												
39000(393)												
47000(473)												
68000(683)												

Capacitance Table (High Voltage Capacitors)

Size	0603(10)	0805(21)		1206(31)								
	X7R(B)											
TC	X7R(B)											
Rated V	100(C)	100(C)	200(D)	250(E)	100(C)	200(D)	250(E)	500(G)	630(H)	1000(I)	2000(J)	
Capacitance -pF- (part numbering code) and thickness -mm-												
220(221)												
330(331)												
470(471)												
680(681)												
1000(102)												
1500(152)												
2200(222)												
3300(332)												
4700(472)												
6800(682)												
10000(103)												
15000(153)												
22000(223)												
33000(333)												
47000(473)												
68000(683)												
100000(104)												
150000(154)												

Size	1210(32)					1808(42)
	X7R(B)					
TC	X7R(B)					
Rated V	100(C)	250(E)	500(G)	1000(I)	2000(J)	2000(J)
Capacitance -pF- (part numbering code) and thickness -mm-						
470(471)						
1000(102)						
2200(222)						
3300(332)						
4700(472)						
6800(682)						
10000(103)						
15000(153)						
22000(223)						
33000(333)						
47000(473)						
68000(683)						
100000(104)						
150000(154)						
220000(224)						
330000(334)						
470000(474)						
680000(684)						
1000000(105)						

 :X7R(B)
 :X5R(A)
 :Y5V(F)
 :COG(C)
 :X6S(X)

★ () Tip & Ring: A special CODE will be applicable.

Capacitance Table (High Voltage Capacitors)

Size	1812(43)						2220(55)					
	X7R(B)											
	TC	X7R(B)										
Rated V	100(C)	200(D)	250(E)	500(G)	1000(I)	2000(J)	100(C)	250(E)	500(G)	1000(I)	2000(J)	
Capacitance -pF- (part numbering code) and thickness -mm-												
2700(272)						1.25 (F)						
3300(332)												
3900(392)												
4700(472)												
5600(562)						1.25 (F)					1.6 (H)	
6800(682)												
8200(822)												
10000(103)												
12000(123)						1.6 (H)						
15000(153)												
18000(183)												
22000(223)												
27000(273)					1.25 (F)	2.5 (J)						
33000(333)												
39000(393)												
47000(473)												
56000(563)												
68000(683)		1.25 (F)			1.6 (H)						2.0 (I)	
82000(823)					2.0 (I)							
100000(104)												
120000(124)												
150000(154)										1.6 (H)		
180000(184)					2.5 (J)					2.0 (I)		
220000(224)	1.25 (F)									2.5 (J)		
270000(274)												
330000(334)												
470000(474)	1.6 (H)									2.5 (J)		
560000(564)												
680000(684)	2.0 (I)											
820000(824)												
1000000(105)	2.5 (J)											
1500000(155)										1.6 (H)		
2200000(225)										2.0 (I)		
3300000(335)										2.5 (J)		
4700000(475)												

■:X7R(B) ■:X5R(A) ■:Y5V(F) ■:COG(C) ■:X6S(X)

★() Tip & Ring: A special CODE will be applicable.

Product Line UP (High Voltage Capacitors)

Part Number	TC Code	Temperature Characteristics	Rated Voltage (Vdc)	Size L × W (mm)	Capacitance	Capacitance Tolerance	Thickness max (mm)	
CL42C100JKFNND	□	COG(EIA)	±30ppm/°C(-55~+125°C)	3000	4.50X2.00	10pF	±5%	1.35
CL31C220JHNNND	□	COG(EIA)	±30ppm/°C(-55~+125°C)	2000	3.20X1.60	22pF	±5%	1.80
CL31C470JHNNND	□	COG(EIA)	±30ppm/°C(-55~+125°C)	2000	3.20X1.60	47pF	±5%	1.80
CL32C101JFNND	□	COG(EIA)	±30ppm/°C(-55~+125°C)	2000	3.20X2.50	100pF	±5%	1.35
CL31C680JIFNND	□	COG(EIA)	±30ppm/°C(-55~+125°C)	1000	3.20X1.60	68pF	±5%	1.35
CL31C101JIFNND	□	COG(EIA)	±30ppm/°C(-55~+125°C)	1000	3.20X1.60	100pF	±5%	1.35
CL43C102JIHNNND	□	COG(EIA)	±30ppm/°C(-55~+125°C)	1000	4.50X3.20	1.0nF	±5%	1.80
CL43C122JIIHNNND	□	COG(EIA)	±30ppm/°C(-55~+125°C)	1000	4.50X3.20	1.2nF	±5%	2.20
CL43C182JIIHNNND	□	COG(EIA)	±30ppm/°C(-55~+125°C)	1000	4.50X3.20	1.8nF	±5%	2.80
CL31C470JHFNNND	□	COG(EIA)	±30ppm/°C(-55~+125°C)	630	3.20X1.60	47pF	±5%	1.35
CL31C680JHFNNND	□	COG(EIA)	±30ppm/°C(-55~+125°C)	630	3.20X1.60	68pF	±5%	1.35
CL31C101JHFNNND	□	COG(EIA)	±30ppm/°C(-55~+125°C)	630	3.20X1.60	100pF	±5%	1.35
CL31C150JGFNNND	□	COG(EIA)	±30ppm/°C(-55~+125°C)	500	3.20X1.60	15pF	±5%	1.35
CL31C180JGFNNND	□	COG(EIA)	±30ppm/°C(-55~+125°C)	500	3.20X1.60	18pF	±5%	1.35
CL31C220JGFNNND	□	COG(EIA)	±30ppm/°C(-55~+125°C)	500	3.20X1.60	22pF	±5%	1.35
CL31C270JGFNNND	□	COG(EIA)	±30ppm/°C(-55~+125°C)	500	3.20X1.60	27pF	±5%	1.35
CL31C330JGFNNND	□	COG(EIA)	±30ppm/°C(-55~+125°C)	500	3.20X1.60	33pF	±5%	1.35
CL31C390JGFNNND	□	COG(EIA)	±30ppm/°C(-55~+125°C)	500	3.20X1.60	39pF	±5%	1.35
CL31C470JGFNNND	□	COG(EIA)	±30ppm/°C(-55~+125°C)	500	3.20X1.60	47pF	±5%	1.35
CL31C560JGFNNND	□	COG(EIA)	±30ppm/°C(-55~+125°C)	500	3.20X1.60	56pF	±5%	1.35
CL31C680JGFNNND	□	COG(EIA)	±30ppm/°C(-55~+125°C)	500	3.20X1.60	68pF	±5%	1.35
CL31C820JGFNND	□	COG(EIA)	±30ppm/°C(-55~+125°C)	500	3.20X1.60	82pF	±5%	1.35
CL31C101JGFNND	□	COG(EIA)	±30ppm/°C(-55~+125°C)	500	3.20X1.60	100pF	±5%	1.35
CL31C121JGFNND	□	COG(EIA)	±30ppm/°C(-55~+125°C)	500	3.20X1.60	120pF	±5%	1.35
CL31C151JGFNND	□	COG(EIA)	±30ppm/°C(-55~+125°C)	500	3.20X1.60	150pF	±5%	1.35
CL31C181JGFNND	□	COG(EIA)	±30ppm/°C(-55~+125°C)	500	3.20X1.60	180pF	±5%	1.35
CL31C221JGFNND	□	COG(EIA)	±30ppm/°C(-55~+125°C)	500	3.20X1.60	220pF	±5%	1.35
CL31C271JGFNND	□	COG(EIA)	±30ppm/°C(-55~+125°C)	500	3.20X1.60	270pF	±5%	1.35
CL31C331JGFNND	□	COG(EIA)	±30ppm/°C(-55~+125°C)	500	3.20X1.60	330pF	±5%	1.35
CL31C471JGFNND	□	COG(EIA)	±30ppm/°C(-55~+125°C)	500	3.20X1.60	470pF	±5%	1.35
CL31C561JGFNND	□	COG(EIA)	±30ppm/°C(-55~+125°C)	500	3.20X1.60	560pF	±5%	1.35
CL31C681JGFNND	□	COG(EIA)	±30ppm/°C(-55~+125°C)	500	3.20X1.60	680pF	±5%	1.80
CL31C102JGHNNND	□	COG(EIA)	±30ppm/°C(-55~+125°C)	500	3.20X1.60	1.0nF	±5%	1.80
CL21C101JECNNND	□	COG(EIA)	±30ppm/°C(-55~+125°C)	250	2.00X1.25	100pF	±5%	1.00
CL21C150JDCANNND	□	COG(EIA)	±30ppm/°C(-55~+125°C)	200	2.00X1.25	15pF	±5%	1.00

※ □ mark means packaging code. If you want to learn the code or quantity in detail, please see p 58.

Product Line UP (High Voltage Capacitors)

Part Number	TC Code	Temperature Characteristics	Rated Voltage (Vdc)	Size L×W (mm)	Capacitance	Capacitance Tolerance	Thickness max (mm)
CL21C180JDCNNN □	COG(EIA)	±30ppm/°C(-55~+125°C)	200	2.00X1.25	18pF	±5%	1.00
CL21C330JDCNNN □	COG(EIA)	±30ppm/°C(-55~+125°C)	200	2.00X1.25	33pF	±5%	1.00
CL21C390JDCNNN □	COG(EIA)	±30ppm/°C(-55~+125°C)	200	2.00X1.25	39pF	±5%	1.00
CL21C470JDCNNN □	COG(EIA)	±30ppm/°C(-55~+125°C)	200	2.00X1.25	47pF	±5%	1.00
CL21C560JDCNNN □	COG(EIA)	±30ppm/°C(-55~+125°C)	200	2.00X1.25	56pF	±5%	1.00
CL21C680JDCNNN □	COG(EIA)	±30ppm/°C(-55~+125°C)	200	2.00X1.25	68pF	±5%	1.00
CL21C101JDCNNN □	COG(EIA)	±30ppm/°C(-55~+125°C)	200	2.00X1.25	100pF	±5%	1.00
CL21C121JDCNNN □	COG(EIA)	±30ppm/°C(-55~+125°C)	200	2.00X1.25	120pF	±5%	1.00
CL21C221JDCNNN □	COG(EIA)	±30ppm/°C(-55~+125°C)	200	2.00X1.25	220pF	±5%	1.00
CL21C102JDFNNN □	COG(EIA)	±30ppm/°C(-55~+125°C)	200	2.00X1.25	1.0nF	±5%	1.35
CL10C100JC8NNN □	COG(EIA)	±30ppm/°C(-55~+125°C)	100	1.60X0.80	10pF	±5%	0.90
CL21C100JCANNN □	COG(EIA)	±30ppm/°C(-55~+125°C)	100	2.00X1.25	10pF	±5%	0.75
CL21C120JCANNN □	COG(EIA)	±30ppm/°C(-55~+125°C)	100	2.00X1.25	12pF	±5%	0.75
CL10C150JC8NNN □	COG(EIA)	±30ppm/°C(-55~+125°C)	100	1.60X0.80	15pF	±5%	0.90
CL21C150JCANNN □	COG(EIA)	±30ppm/°C(-55~+125°C)	100	2.00X1.25	15pF	±5%	0.75
CL21C180JCANNN □	COG(EIA)	±30ppm/°C(-55~+125°C)	100	2.00X1.25	18pF	±5%	0.75
CL21C220JCANNN □	COG(EIA)	±30ppm/°C(-55~+125°C)	100	2.00X1.25	22pF	±5%	0.75
CL21C270JCANNN □	COG(EIA)	±30ppm/°C(-55~+125°C)	100	2.00X1.25	27pF	±5%	0.75
CL21C330JCANNN □	COG(EIA)	±30ppm/°C(-55~+125°C)	100	2.00X1.25	33pF	±5%	0.75
CL10C330JC8NNN □	COG(EIA)	±30ppm/°C(-55~+125°C)	100	1.60X0.80	33pF	±5%	0.90
CL10C390JC8NNN □	COG(EIA)	±30ppm/°C(-55~+125°C)	100	1.60X0.80	39pF	±5%	0.90
CL10C470JC8NNN □	COG(EIA)	±30ppm/°C(-55~+125°C)	100	1.60X0.80	47pF	±5%	0.90
CL21C470JCANNN □	COG(EIA)	±30ppm/°C(-55~+125°C)	100	2.00X1.25	47pF	±5%	0.75
CL21C560JCCNNN □	COG(EIA)	±30ppm/°C(-55~+125°C)	100	2.00X1.25	47pF	±5%	0.75
CL21C680JCANNN □	COG(EIA)	±30ppm/°C(-55~+125°C)	100	2.00X1.25	68pF	±5%	0.75
CL31C680JCCNNN □	COG(EIA)	±30ppm/°C(-55~+125°C)	100	3.20X1.60	68pF	±5%	1.00
CL21C820JCCNNN □	COG(EIA)	±30ppm/°C(-55~+125°C)	100	3.20X1.60	82pF	±5%	1.00
CL10C101JC8NNN □	COG(EIA)	±30ppm/°C(-55~+125°C)	100	1.60X0.80	100pF	±5%	0.90
CL21C101JCANNN □	COG(EIA)	±30ppm/°C(-55~+125°C)	100	2.00X1.25	100pF	±5%	0.75
CL10C121JC8NNN □	COG(EIA)	±30ppm/°C(-55~+125°C)	100	1.60X0.80	120pF	±5%	0.90
CL10C151JC8NNN □	COG(EIA)	±30ppm/°C(-55~+125°C)	100	1.60X0.80	150pF	±5%	0.90
CL21C151JCANNN □	COG(EIA)	±30ppm/°C(-55~+125°C)	100	2.00X1.25	150pF	±5%	0.75
CL21C221JCANNN □	COG(EIA)	±30ppm/°C(-55~+125°C)	100	2.00X1.25	220pF	±5%	0.75
CL31C271JCCNNN □	COG(EIA)	±30ppm/°C(-55~+125°C)	100	3.20X1.60	270pF	±5%	1.00
CL21C331JCANNN □	COG(EIA)	±30ppm/°C(-55~+125°C)	100	2.00X1.25	330pF	±5%	0.75

※ □mark means packaging code. If you want to learn the code or quantity in detail, please see p 58.

Product Line UP (High Voltage Capacitors)

Part Number	TC Code	Temperature Characteristics	Rated Voltage (Vdc)	Size L×W (mm)	Capacitance	Capacitance Tolerance	Thickness max (mm)
CL10C331JC8NNN □	COG(EIA)	±30ppm/°C(-55~+125°C)	100	1.60X0.80	330pF	±5%	0.90
CL31C391JCCNNN □	COG(EIA)	±30ppm/°C(-55~+125°C)	100	3.20X1.60	390pF	±5%	1.00
CL10C471JC8NNN □	COG(EIA)	±30ppm/°C(-55~+125°C)	100	1.60X0.80	470pF	±5%	0.90
CL21C471JCCNNN □	COG(EIA)	±30ppm/°C(-55~+125°C)	100	2.00X1.25	470pF	±5%	1.00
CL21C561JCCNNN □	COG(EIA)	±30ppm/°C(-55~+125°C)	100	2.00X1.25	560pF	±5%	1.00
CL31C561JCCNNN □	COG(EIA)	±30ppm/°C(-55~+125°C)	100	3.20X1.60	560pF	±5%	1.00
CL21C681JCCNNN □	COG(EIA)	±30ppm/°C(-55~+125°C)	100	2.00X1.25	680pF	±5%	1.00
CL21C102JCFNNN □	COG(EIA)	±30ppm/°C(-55~+125°C)	100	2.00X1.25	1.0nF	±5%	1.35
CL31C102JCCNNN □	COG(EIA)	±30ppm/°C(-55~+125°C)	100	3.20X1.60	1.0nF	±5%	1.00
CL31C152JCCNNN □	COG(EIA)	±30ppm/°C(-55~+125°C)	100	3.20X1.60	1.5nF	±5%	1.00
CL31C222JCCNNN □	COG(EIA)	±30ppm/°C(-55~+125°C)	100	3.20X1.60	2.2nF	±5%	1.00
CL31C392JCHNNN □	COG(EIA)	±30ppm/°C(-55~+125°C)	100	3.20X1.60	3.9nF	±5%	1.80

Part Number	TC Code	Temperature Characteristics	Rated Voltage (Vdc)	Size L×W (mm)	Capacitance	Capacitance Tolerance	Thickness max (mm)
CL31B102KJHNNN □	X7R(EIA)	±15%(-55~+125°C)	2000	3.20×1.60	1.0nF	±10%	1.80
CL32B102KJFNNN □	X7R(EIA)	±15%(-55~+125°C)	2000	3.20×2.50	1.0nF	±10%	1.35
CL43B102KJFNNN □	X7R(EIA)	±15%(-55~+125°C)	2000	4.50×3.20	1.0nF	±10%	1.35
CL43B152KJFNNN □	X7R(EIA)	±15%(-55~+125°C)	2000	4.50×3.20	1.5nF	±10%	1.35
CL31B102KIFNNN □	X7R(EIA)	±15%(-55~+125°C)	1000	3.20×1.60	1.0nF	±10%	1.35
CL31B222KIFNNN □	X7R(EIA)	±15%(-55~+125°C)	1000	3.20×1.60	2.2nF	±10%	1.35
CL43B222KIFNNN □	X7R(EIA)	±15%(-55~+125°C)	1000	4.50×3.20	2.2nF	±10%	1.35
CL43B103KIFNNN □	X7R(EIA)	±15%(-55~+125°C)	1000	4.50×3.20	10nF	±10%	1.35
CL31B102KHFNNN □	X7R(EIA)	±15%(-55~+125°C)	630	3.20×1.60	1.0nF	±10%	1.35
CL32B472KHFNNN □	X7R(EIA)	±15%(-55~+125°C)	630	3.20×2.50	4.7nF	±10%	1.35
CL31B103KHFNNN □	X7R(EIA)	±15%(-55~+125°C)	630	3.20×1.60	10nF	±10%	1.35
CL31B221KGFNNN □	X7R(EIA)	±15%(-55~+125°C)	500	3.20×1.60	0.22nF	±10%	1.35
CL31B471KGFNNN □	X7R(EIA)	±15%(-55~+125°C)	500	3.20×1.60	0.47nF	±10%	1.35
CL31B102KGFNNN □	X7R(EIA)	±15%(-55~+125°C)	500	3.20×1.60	1.0nF	±10%	1.35
CL31B152KGFNNN □	X7R(EIA)	±15%(-55~+125°C)	500	3.20×1.60	1.5nF	±10%	1.35

※ □mark means packaging code. If you want to learn the code or quantity in detail, please see p 58.

High Voltage Capacitors

Product Line UP (High Voltage Capacitors)

Part Number	TC Code	Temperature Characteristics	Rated Voltage (Vdc)	Size L×W (mm)	Capacitance	Capacitance Tolerance	Thickness max (mm)
CL31B222KGFNNN □	X7R(EIA)	±15%(-55~+125℃)	500	3.20×1.60	2.2nF	±10%	1.35
CL31B332KGFNNN □	X7R(EIA)	±15%(-55~+125℃)	500	3.20×1.60	3.3nF	±10%	1.35
CL31B472KGFNNN □	X7R(EIA)	±15%(-55~+125℃)	500	3.20×1.60	4.7nF	±10%	1.35
CL31B682KGFNNN □	X7R(EIA)	±15%(-55~+125℃)	500	3.20×1.60	6.8nF	±10%	1.35
CL31B103KGFNNN □	X7R(EIA)	±15%(-55~+125℃)	500	3.20×1.60	10nF	±10%	1.35
CL32B153KGFNNN □	X7R(EIA)	±15%(-55~+125℃)	500	3.20×2.50	15nF	±10%	1.35
CL32B223KGFNNN □	X7R(EIA)	±15%(-55~+125℃)	500	3.20×2.50	22nF	±10%	1.35
CL43B473KGFNNN □	X7R(EIA)	±15%(-55~+125℃)	500	4.50×3.20	47nF	±10%	1.35
CL43B104KGJNNN □	X7R(EIA)	±15%(-55~+125℃)	500	4.50×3.20	100nF	±10%	2.20
CL21B153KEFNNN □	X7R(EIA)	±15%(-55~+125℃)	250	2.00×1.25	15nF	±10%	1.35
CL31B473KEHNNN □	X7R(EIA)	±15%(-55~+125℃)	250	3.20×1.60	47nF	±10%	1.80
CL32B104KEJNNN □	X7R(EIA)	±15%(-55~+125℃)	250	3.20×2.50	100nF	±10%	2.80
CL43B474KEJNNN □	X7R(EIA)	±15%(-55~+125℃)	250	4.50×3.20	470nF	±10%	2.80
CL21B221KDCNNN □	X7R(EIA)	±15%(-55~+125℃)	200	2.00×1.25	0.22nF	±10%	1.00
CL21B331KDCNNN □	X7R(EIA)	±15%(-55~+125℃)	200	2.00×1.25	0.33nF	±10%	1.00
CL31B471KDCNNN □	X7R(EIA)	±15%(-55~+125℃)	200	3.20×1.60	0.47nF	±10%	1.00
CL21B102KDCNNN □	X7R(EIA)	±15%(-55~+125℃)	200	2.00×1.25	1.0nF	±10%	1.00
CL21B222KDCNNN □	X7R(EIA)	±15%(-55~+125℃)	200	2.00×1.25	2.2nF	±10%	1.00
CL31B222KDCNNN □	X7R(EIA)	±15%(-55~+125℃)	200	3.20×1.60	2.2nF	±10%	1.00
CL21B472KDCNNN □	X7R(EIA)	±15%(-55~+125℃)	200	2.00×1.25	4.7nF	±10%	1.00
CL31B472KDCNNN □	X7R(EIA)	±15%(-55~+125℃)	200	3.20×1.60	4.7nF	±10%	1.00
CL21B103KDCNNN □	X7R(EIA)	±15%(-55~+125℃)	200	2.00×1.25	10nF	±10%	1.00
CL31B153KDCNNN □	X7R(EIA)	±15%(-55~+125℃)	200	3.20×1.60	15nF	±10%	1.00
CL31B223KDCNNN □	X7R(EIA)	±15%(-55~+125℃)	200	3.20×1.60	22nF	±10%	1.00
CL31B333KDFNNN □	X7R(EIA)	±15%(-55~+125℃)	200	3.20×1.60	33nF	±10%	1.35
CL31B473KDFNNN □	X7R(EIA)	±15%(-55~+125℃)	200	3.20×1.60	47nF	±10%	1.35
CL32B473KDHNNN □	X7R(EIA)	±15%(-55~+125℃)	200	3.20×2.50	47nF	±10%	1.80
CL31B104KDHNNN □	X7R(EIA)	±15%(-55~+125℃)	200	3.20×1.60	100nF	±10%	1.80
CL43B104KDFNNN □	X7R(EIA)	±15%(-55~+125℃)	200	4.50×3.20	100nF	±10%	1.35
CL21B221KCANNN □	X7R(EIA)	±15%(-55~+125℃)	100	2.00×1.25	0.22nF	±10%	0.75
CL21B471KCANNN □	X7R(EIA)	±15%(-55~+125℃)	100	2.00×1.25	0.47nF	±10%	0.75
CL10B102KC8NNN □	X7R(EIA)	±15%(-55~+125℃)	100	1.60×0.80	1.0nF	±10%	0.90
CL21B102KCANNN □	X7R(EIA)	±15%(-55~+125℃)	100	2.00×1.25	1.0nF	±10%	0.75
CL21B222KCANNN □	X7R(EIA)	±15%(-55~+125℃)	100	2.00×1.25	2.2nF	±10%	0.75
CL21B332KCANNN □	X7R(EIA)	±15%(-55~+125℃)	100	2.00×1.25	3.3nF	±10%	0.75

※ □mark means packaging code. If you want to learn the code or quantity in detail, please see p 58.

Product Line UP (High Voltage Capacitors)

Part Number	TC Code	Temperature Characteristics	Rated Voltage (Vdc)	Size L×W (mm)	Capacitance	Capacitance Tolerance	Thickness max (mm)
CL10B472KC8NNN □	X7R(EIA)	±15%(-55~+125℃)	100	1.60×0.80	4.7nF	±10%	0.90
CL21B472KCANNN □	X7R(EIA)	±15%(-55~+125℃)	100	2.00×1.25	4.7nF	±10%	0.75
CL21B682KCANNN □	X7R(EIA)	±15%(-55~+125℃)	100	2.00×1.25	6.8nF	±10%	0.75
CL10B103KC8NNN □	X7R(EIA)	±15%(-55~+125℃)	100	1.60×0.80	10nF	±10%	0.90
CL21B103KCANNN □	X7R(EIA)	±15%(-55~+125℃)	100	2.00×1.25	10nF	±10%	0.75
CL32B103KCFNNN □	X7R(EIA)	±15%(-55~+125℃)	100	3.20×2.50	10nF	±10%	1.35
CL21B153KCCNNN □	X7R(EIA)	±15%(-55~+125℃)	100	2.00×1.25	15nF	±10%	1.00
CL31B153KCCNNN □	X7R(EIA)	±15%(-55~+125℃)	100	3.20×1.60	15nF	±10%	1.00
CL21B223KCFNNN □	X7R(EIA)	±15%(-55~+125℃)	100	2.00×1.50	22nF	±10%	1.35
CL31B223KCCNNN □	X7R(EIA)	±15%(-55~+125℃)	100	3.20×1.60	22nF	±10%	1.00
CL31B333KCCNNN □	X7R(EIA)	±15%(-55~+125℃)	100	3.20×1.60	33nF	±10%	1.00
CL21B473KCFNNN □	X7R(EIA)	±15%(-55~+125℃)	100	2.00×1.25	47nF	±10%	1.35
CL31B473KCCNNN □	X7R(EIA)	±15%(-55~+125℃)	100	3.20×1.60	47nF	±10%	1.00
CL31B104KCFNNN □	X7R(EIA)	±15%(-55~+125℃)	100	3.20×1.60	100nF	±10%	1.35
CL31B154KCHNNN □	X7R(EIA)	±15%(-55~+125℃)	100	3.20×1.60	150nF	±10%	1.80
CL32B154KCFNNN □	X7R(EIA)	±15%(-55~+125℃)	100	3.20×2.50	150nF	±10%	1.35
CL32B224KCHNNN □	X7R(EIA)	±15%(-55~+125℃)	100	3.20×2.50	220nF	±10%	1.80
CL43B224KCFNNN □	X7R(EIA)	±15%(-55~+125℃)	100	4.50×3.20	220nF	±10%	1.35
CL32B334KCHNNN □	X7R(EIA)	±15%(-55~+125℃)	100	3.20×2.50	330nF	±10%	1.80
CL43B334KCFNNN □	X7R(EIA)	±15%(-55~+125℃)	100	4.50×3.20	330nF	±10%	1.35
CL32B474KJNNN □	X7R(EIA)	±15%(-55~+125℃)	100	3.20×2.50	470nF	±10%	2.20
CL43B474KCHNNN □	X7R(EIA)	±15%(-55~+125℃)	100	4.50×3.20	470nF	±10%	1.80
CL31B105KCHNNN □	X7R(EIA)	±15%(-55~+125℃)	100	3.20×1.60	1.0μF	±10%	1.80
CL32B105KJNNN □	X7R(EIA)	±15%(-55~+125℃)	100	3.20×2.50	1.0μF	±10%	2.80
CL43B105KJNNN □	X7R(EIA)	±15%(-55~+125℃)	100	4.50×3.20	1.0μF	±10%	2.80
CL55B105KCHNNN □	X7R(EIA)	±15%(-55~+125℃)	100	5.70×5.00	1.0μF	±10%	1.80

※ □mark means packaging code. If you want to learn the code or quantity in detail, please see p 58.

Array Type Capacitors

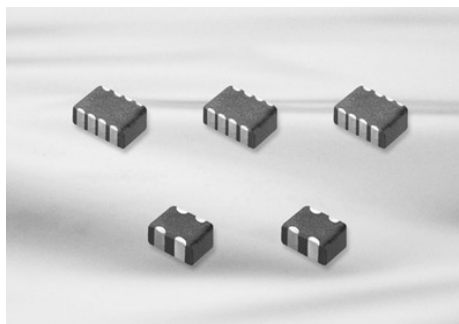

Feature

- Reduction in required space (more than 50%)
- Reduction in cost and time for replacement of PCB
- Reduction in amount of solder joints
- Easier PCB design
- Reduced waste from tape and reel packaging process

Application

- A bypass for digital and analog signal line noise generated by telecommunication equipment and other common electronic circuits

Structure and Dimensions

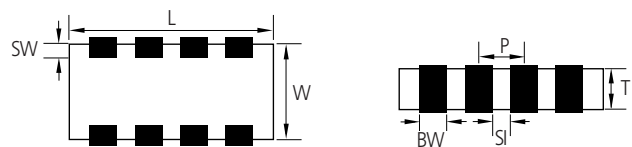

Code	EIA Code	Dimension (mm)					
		L	W	T	BW	SW	P
A	0504	1.37 ± 0.15	1.0 ± 0.15	0.60 ± 0.06 0.80 ± 0.08	0.36 ± 0.1	0.2 ± 0.1	0.64 ± 0.1
A	0805	2.0 ± 0.15	1.25 ± 0.15	0.85 ± 0.1	0.5 ± 0.2	0.25 ± 0.15	1.0 ± 0.1
B	0805	2.0 ± 0.15	1.25 ± 0.15	0.85 ± 0.1	0.25 ± 0.1	0.25 ± 0.15	0.5 ± 0.1
B	1206	3.2 ± 0.15	1.6 ± 0.15	0.85 ± 0.15	0.4 ± 0.2	0.3 ± 0.15	0.8 ± 0.2

Structure and Control Code

A : ARRAY(2-element)

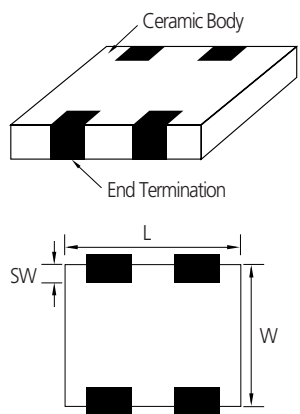

B : ARRAY(4-element)

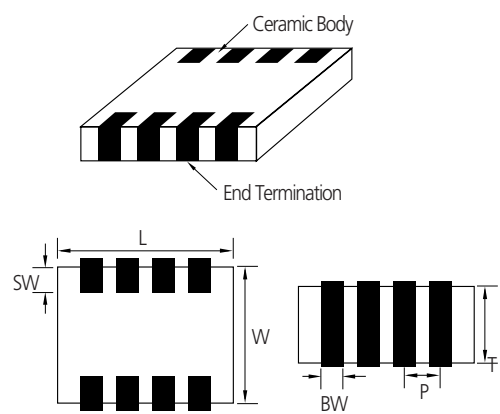

Capacitance Table (Array Type Capacitors)

Size	0504(14)				0805(21)				1206(31)						
	X7R(B)/X5R(A)				X5R(A)		X7R(B)		COG(C)	X7R(B)		Y5V(F)			
TC	2				2		4		4	4		4			
Element	2				2		4		4	4		4			
Rated V	6.3(Q)	10(P)	16(O)	25(A)	6.3(Q)	10(P)	16(O)	10(P)	16(O)	50(B)	16(O)	25(A)	50(B)	25(A)	50(B)

Capacitance -pF- (part numbering code) and thickness -mm- (part numbering code)

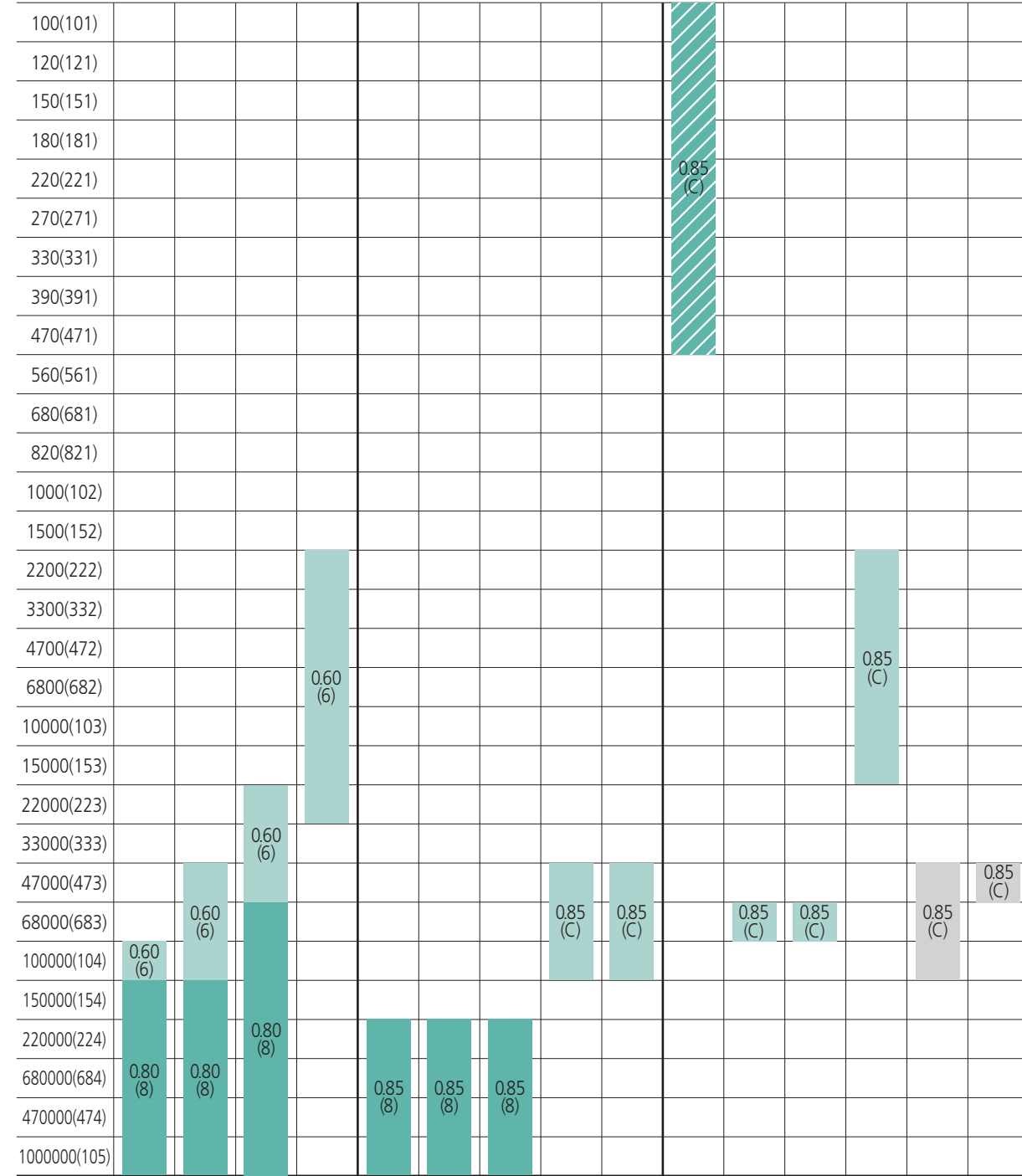

Legend: X7R(B) (light blue), X5R(A) (medium blue), Y5V(F) (grey), COG(C) (hatched), X6S(X) (dotted).
 ※ Please consult us for special capacitance and high voltage(100V)

Product Line UP (Array Type Capacitors)

Part Number	TC Code	Temperature Characteristics	Element Type	Size L×W (mm)	Capacitance	Capacitance Tolerance	Rated Voltage (Vdc)	Thickness max (mm)
CL31C100JBCNBN □	COG(EIA)	±30ppm/°C(-55~+125°C)	4-Array	3.20×1.60	10pF	±5%	50	1.0
CL31C150JBCNBN □	COG(EIA)	±30ppm/°C(-55~+125°C)	4-Array	3.20×1.60	15pF	±5%	50	1.0
CL31C220JBCNBN □	COG(EIA)	±30ppm/°C(-55~+125°C)	4-Array	3.20×1.60	22pF	±5%	50	1.0
CL31C270JBCNBN □	COG(EIA)	±30ppm/°C(-55~+125°C)	4-Array	3.20×1.60	27pF	±10%	50	1.0
CL31C330KBCNBN □	COG(EIA)	±30ppm/°C(-55~+125°C)	4-Array	3.20×1.60	33pF	±10%	50	1.0
CL31C390KBCNBN □	COG(EIA)	±30ppm/°C(-55~+125°C)	4-Array	3.20×1.60	39pF	±10%	50	1.0
CL31C470JBCNBN □	COG(EIA)	±30ppm/°C(-55~+125°C)	4-Array	3.20×1.60	47pF	±5%	50	1.0
CL31C680JBCNBN □	COG(EIA)	±30ppm/°C(-55~+125°C)	4-Array	3.20×1.60	68pF	±5%	50	1.0
CL31C820JBCNBN □	COG(EIA)	±30ppm/°C(-55~+125°C)	4-Array	3.20×1.60	82pF	±5%	50	1.0
CL31C101JBCNBN □	COG(EIA)	±30ppm/°C(-55~+125°C)	4-Array	3.20×1.60	100pF	±5%	50	1.0
CL31C151KBCNBN □	COG(EIA)	±30ppm/°C(-55~+125°C)	4-Array	3.20×1.60	150pF	±10%	50	1.0
CL31C181JBCNBN □	COG(EIA)	±30ppm/°C(-55~+125°C)	4-Array	3.20×1.60	180pF	±5%	50	1.0
CL31C331JBCNBN □	COG(EIA)	±30ppm/°C(-55~+125°C)	4-Array	3.20×1.60	330pF	±5%	50	1.0
CL31C471JBCNBN □	COG(EIA)	±30ppm/°C(-55~+125°C)	4-Array	3.20×1.60	470pF	±5%	50	1.0

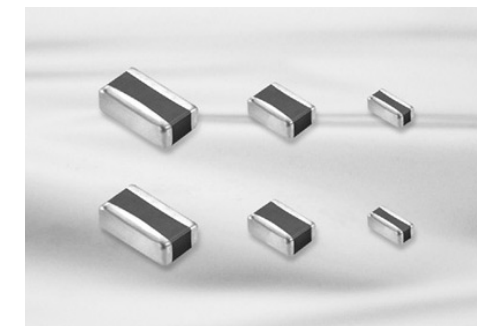

Feature

- Low ESL, good for noise reduction for high frequency
- Highly reliable tolerance and high speed automatic chip placement on PCBs
- Highly reliable performance
- Highly resistant termination metal
- Tape & reel for surface mount assembly

Application

- High Speed Microprocessor
- High Frequency Digital Equipment

Structure and Dimensions

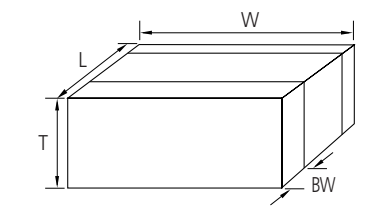

Part Number	TC Code	Temperature Characteristics	Element Type	Size L×W (mm)	Capacitance	Capacitance Tolerance	Rated Voltage (Vdc)	Thickness max (mm)
CL21B471KBCNBN □	X7R(EIA)	±15%(-55~+125°C)	4-Array	2.00×1.25	470pF	±5%	50	0.95
CL31B102MBCNBN □	X7R(EIA)	±15%(-55~+125°C)	4-Array	3.20×1.60	1.0nF	±20%	50	1.0
CL31B103MBCNBN □	X7R(EIA)	±15%(-55~+125°C)	4-Array	3.20×1.60	10nF	±20%	50	1.0
CL31B153KBCNBN □	X7R(EIA)	±15%(-55~+125°C)	4-Array	3.20×1.60	15nF	±10%	50	1.0
CL31B473KACNBN □	X7R(EIA)	±15%(-55~+125°C)	4-Array	3.20×1.60	47nF	±10%	25	1.0
CL31F473ZBCNBN □	Y5V(EIA)	-82~+22%(-30~+85°C)	4-Array	3.20×1.60	47nF	80%/-20%	50	1.0
CL31B104KACNBN □	X7R(EIA)	±15%(-55~+125°C)	4-Array	3.20×1.60	100nF	±10%	25	1.0
CL31F104ZACNBN □	Y5V(EIA)	-82~+22%(-30~+85°C)	4-Array	3.20×1.60	100nF	80%/-20%	25	1.0
CL21B104KOCNBN □	X7R(EIA)	±15%(-55~+125°C)	4-Array	2.00×1.25	100nF	±10%	16	0.95
CL31B104KOCNBN □	X7R(EIA)	±15%(-55~+125°C)	4-Array	3.20×1.60	100nF	±10%	16	1.0
CL21B104MPCNBN □	X7R(EIA)	±15%(-55~+125°C)	4-Array	2.00×1.25	100nF	±20%	10	0.95
CL21A105KOCNAN □	X5R(EIA)	±15%(-55~+85°C)	2-Array	2.00×1.25	1.0uF	±10%	16	0.95
CL14A105KP8NAN □	X5R(EIA)	±15%(-55~+85°C)	2-Array	1.40×1.00	1.0uF	±10%	10	0.88
CL21A105MPCNAN □	X5R(EIA)	±15%(-55~+85°C)	2-Array	2.00×1.25	1.0uF	±20%	10	0.95

※ □ mark means packaging code. If you want to learn the code or quantity in detail, please see p 58.

Code	EIA Code	Dimension (mm)			
		L	W	T	BW
01	0306	0.8±0.1	1.6±0.1	0.5±0.1	0.15 min.
12	0508	1.25±0.1	2.0±0.1	0.5±0.1 0.85±0.1	0.2 min.
13	0612	1.6±0.2	3.2±0.2	0.85±0.1 1.25±0.15	0.2 min.

Capacitance Table (Low ESL Capacitors)

Size	0306(01)					0508(12)					0612(13)	
	X5R(A) / X7R(B)											
TC	X5R(A) / X7R(B)											
Rated V	6.3(Q)	10(P)	16(O)	25(A)	50(B)	6.3(Q)	10(P)	16(O)	25(A)	50(B)	6.3(Q)	50(B)
Capacitance -uF- (part numbering code)												
0.01(103)					0.5 (5)				0.5 (5)			
0.015(153)					0.5 (5)				0.5 (5)	0.85 (C)		0.5 (5)
0.022(223)					0.5 (5)				0.5 (5)	0.85 (C)		0.5 (5)
0.033(333)					0.5 (5)				0.5 (5)	0.85 (C)		0.5 (5)
0.047(473)				0.5 (5)					0.5 (5)	0.85 (C)		0.5 (5)
0.068(683)				0.5 (5)					0.5 (5)	0.85 (C)		0.5 (5)
0.1(104)			0.5 (5)						0.5 (5)	0.85 (C)		0.5 (5)
0.15(154)			0.5 (5)						0.5 (5)	0.85 (C)		0.5 (5)
0.22(224)	0.5 (5)	0.5 (5)							0.5 (5)	0.85 (C)		0.5 (5)
0.33(334)									0.5 (5)	0.85 (C)		0.5 (5)
0.47(474)								0.85 (C)				
0.68(684)							0.85 (C)					
1.0(105)	0.5 (5)						0.85 (C)					
1.5(155)					0.5 (5)							
2.2(225)					0.5 (5)							
3.3(335)					0.5 (5)							
4.7(475)					0.5 (5)							
10(106)											1.25 (F)	

Legend: X7R(B) X5R(A) Y5V(F) COG(C) X6S(X)

Product Line UP (Low ESL Capacitors)

Part Number	TC Code	Temperature Characteristics	Size L x W (mm)	Capacitance	Capacitance Tolerance	Rated Voltage (Vdc)	Thickness max (mm)
CL01B103KB5NLN □	X7R(EIA)	±15%(-55~+125℃)	0.80×1.60	10nF	±10%	50	0.55
CL12B103KB5NLN □	X7R(EIA)	±15%(-55~+125℃)	1.25×2.00	10nF	±10%	50	0.55
CL12B103KBCNLN □	X7R(EIA)	±15%(-55~+125℃)	1.25×2.00	10nF	±10%	50	1.00
CL01B153KB5NLN □	X7R(EIA)	±15%(-55~+125℃)	0.80×1.60	15nF	±10%	50	0.55
CL12B153KB5NLN □	X7R(EIA)	±15%(-55~+125℃)	1.25×2.00	15nF	±10%	50	0.55
CL12B153KBCNLN □	X7R(EIA)	±15%(-55~+125℃)	1.25×2.00	15nF	±10%	50	1.00
CL01B223KB5NLN □	X7R(EIA)	±15%(-55~+125℃)	0.80×1.60	22nF	±10%	50	0.55
CL12B223KB5NLN □	X7R(EIA)	±15%(-55~+125℃)	1.25×2.00	22nF	±10%	50	0.55
CL12B223KBCNLN □	X7R(EIA)	±15%(-55~+125℃)	1.25×2.00	22nF	±10%	50	1.00
CL12B333KB5NLN □	X7R(EIA)	±15%(-55~+125℃)	1.25×2.00	33nF	±10%	50	0.55
CL12B333KBCNLN □	X7R(EIA)	±15%(-55~+125℃)	1.25×2.00	33nF	±10%	50	1.00
CL12B473KBCNLN □	X7R(EIA)	±15%(-55~+125℃)	1.25×2.00	47nF	±10%	50	1.00
CL12B683KBCNLN □	X7R(EIA)	±15%(-55~+125℃)	1.25×2.00	68nF	±10%	50	1.00
CL12B104KBCNLN □	X7R(EIA)	±15%(-55~+125℃)	1.25×2.00	100nF	±10%	50	1.00
CL13B104KB5NLN □	X7R(EIA)	±15%(-55~+125℃)	1.60×3.20	100nF	±10%	50	0.55
CL01B333KA5NLN □	X7R(EIA)	±15%(-55~+125℃)	0.80×1.60	33nF	±10%	25	0.55
CL01B473KA5NLN □	X7R(EIA)	±15%(-55~+125℃)	0.80×1.60	47nF	±10%	25	0.55
CL12B473KA5NLN □	X7R(EIA)	±15%(-55~+125℃)	1.25×2.00	47nF	±10%	25	0.55
CL12B154KACNLN □	X7R(EIA)	±15%(-55~+125℃)	1.25×2.00	150nF	±10%	25	1.00
CL12B224KA5NLN □	X7R(EIA)	±15%(-55~+125℃)	1.25×2.00	220nF	±10%	25	0.55
CL12B224KACNLN □	X7R(EIA)	±15%(-55~+125℃)	1.25×2.00	220nF	±10%	25	1.00
CL01B683KO5NLN □	X7R(EIA)	±15%(-55~+125℃)	0.80×1.60	68nF	±10%	16	0.55
CL12B683KO5NLN □	X7R(EIA)	±15%(-55~+125℃)	1.25×2.00	68nF	±10%	16	0.55
CL01B104KO5NLN □	X7R(EIA)	±15%(-55~+125℃)	0.80×1.60	100nF	±10%	16	0.55
CL12B104KO5NLN □	X7R(EIA)	±15%(-55~+125℃)	1.25×2.00	100nF	±10%	16	0.55
CL12B154KO5NLN □	X7R(EIA)	±15%(-55~+125℃)	1.25×2.00	150nF	±10%	16	0.55
CL12B334KOCNLN □	X7R(EIA)	±15%(-55~+125℃)	1.25×2.00	330nF	±10%	16	1.00
CL01B154KP5NLN □	X7R(EIA)	±15%(-55~+125℃)	0.80×1.60	150nF	±10%	10	0.55
CL01B224KP5NLN □	X7R(EIA)	±15%(-55~+125℃)	0.80×1.60	220nF	±10%	10	0.55
CL12B334KP5NLN □	X7R(EIA)	±15%(-55~+125℃)	1.25×2.00	330nF	±10%	10	0.55
CL12B474KP5NLN □	X7R(EIA)	±15%(-55~+125℃)	1.25×2.00	470nF	±10%	10	0.55
CL12B474KPCNLN □	X7R(EIA)	±15%(-55~+125℃)	1.25×2.00	470nF	±10%	10	1.00
CL12B684KPCNLN □	X7R(EIA)	±15%(-55~+125℃)	1.25×2.00	680nF	±10%	10	1.00
CL12B105KPCNLN □	X7R(EIA)	±15%(-55~+125℃)	1.25×2.00	1.0uF	±10%	10	1.00
CL01A334KQ5NLN □	X5R(EIA)	±15%(-55~+85℃)	0.80×1.60	330nF	±10%	6.3	0.55
CL01A474KQ5NLN □	X5R(EIA)	±15%(-55~+85℃)	0.80×1.60	470nF	±10%	6.3	0.55
CL01A684KQ5NLN □	X5R(EIA)	±15%(-55~+85℃)	0.80×1.60	680nF	±10%	6.3	0.55
CL01A105KQ5NLN □	X5R(EIA)	±15%(-55~+85℃)	0.80×1.60	1.0uF	±10%	6.3	0.55
CL12A155KQCNLN □	X5R(EIA)	±15%(-55~+85℃)	1.25×2.00	1.5uF	±10%	6.3	1.00
CL12A225KQCNLN □	X5R(EIA)	±15%(-55~+85℃)	1.25×2.00	2.2uF	±10%	6.3	1.00
CL12A335KQCNLN □	X5R(EIA)	±15%(-55~+85℃)	1.25×2.00	3.3uF	±10%	6.3	1.00
CL12A475KQCNLN □	X5R(EIA)	±15%(-55~+85℃)	1.25×2.00	4.7uF	±10%	6.3	1.00
CL13A106KQENLN □	X5R(EIA)	±15%(-55~+85℃)	1.60×3.20	10uF	±10%	6.3	1.20

※ □ mark means packaging code. If you want to learn the code or quantity in detail, please see p 58.

Cardboard Paper Tape(4mm)

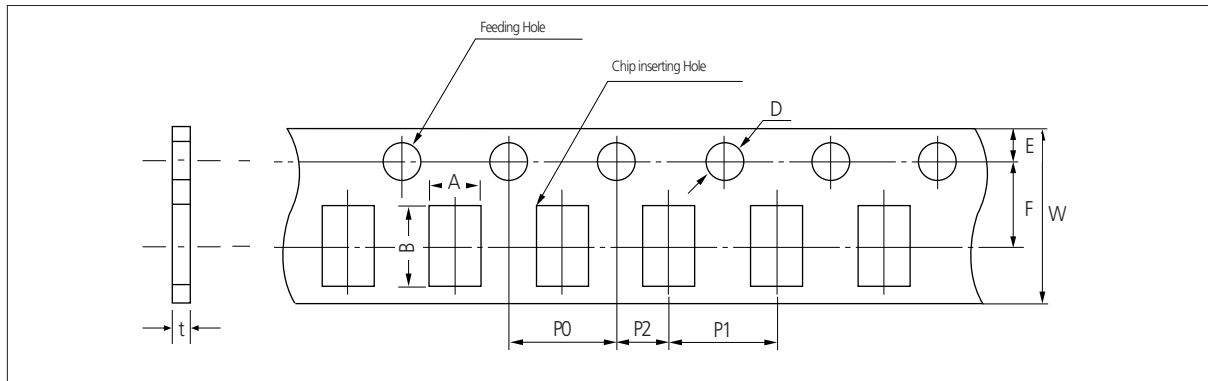

Unit: inch(mm)

Symbol Type		A	B	W	F	E	P1	P2	P0	D	t
Dimension	0504 (1410)	1.3 ±0.2	1.7 ±0.2	8.0 ±0.3	3.5 ±0.05	1.75 ±0.1	4.0 ±0.1	2.0 ±0.05	4.0 ±0.1	Ø1.5 +0.1/-0	1.1 Below
	0603 0306 (1608) (0816)	1.1 ±0.2	1.9 ±0.2								
	0805 0508 (2012) (1220)	1.6 ±0.2	2.4 ±0.2								
	1206 0612 (3216) (1632)	2.0 ±0.2	3.6 ±0.2								

Cardboard Paper Tape(2mm)

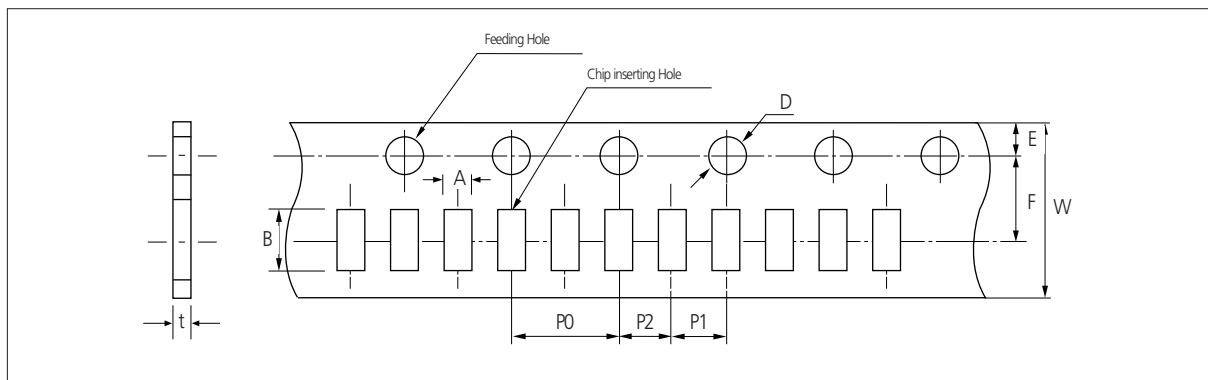

Unit: inch(mm)

Symbol Type		A	B	W	F	E	P1	P2	P0	D	t
Dimension	0201 (0603)	0.38 ±0.03	0.68 ±0.03	8.0 ±0.3	3.5 ±0.05	1.75 ±0.1	2.0 ±0.05	2.0 ±0.05	4.0 ±0.1	Ø1.5 +0.1/-0.03	0.37 ±0.03
	0402 (1005)	0.62 ±0.04	1.12 ±0.04								0.6 ±0.05

Embossed Plastic Tape

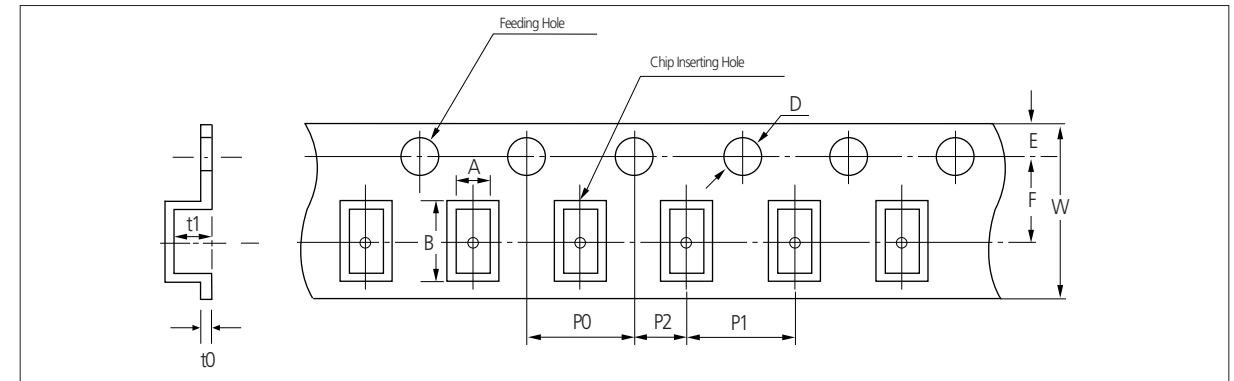

Unit: inch(mm)

Symbol Type		A	B	W	F	E	P1	P2	P0	D	t1	t0
Dimension	0805 (2012)	1.45 ±0.2	2.3 ±0.2	8.0 ±0.3	3.5 ±0.05	1.75 ±0.1	4.0 ±0.1	2.0 ±0.05	4.0 ±0.1	Ø1.5 +0.1/-0	2.5 max	0.6 BELOW
	1206 0612 (3216) (1632)	1.9 ±0.2	3.5 ±0.2									
	1210 (3225)	2.9 ±0.2	3.7 ±0.2									
	1808 (4520)	2.3 ±0.2	4.9 ±0.2	12.0 ±0.3	5.60 ±0.05	8.0 ±0.1	3.8 max					
	1812 (4532)	3.6 ±0.2	4.9 ±0.2									
	2220 (5750)	5.5 ±0.2	6.2 ±0.2									

Taping Size

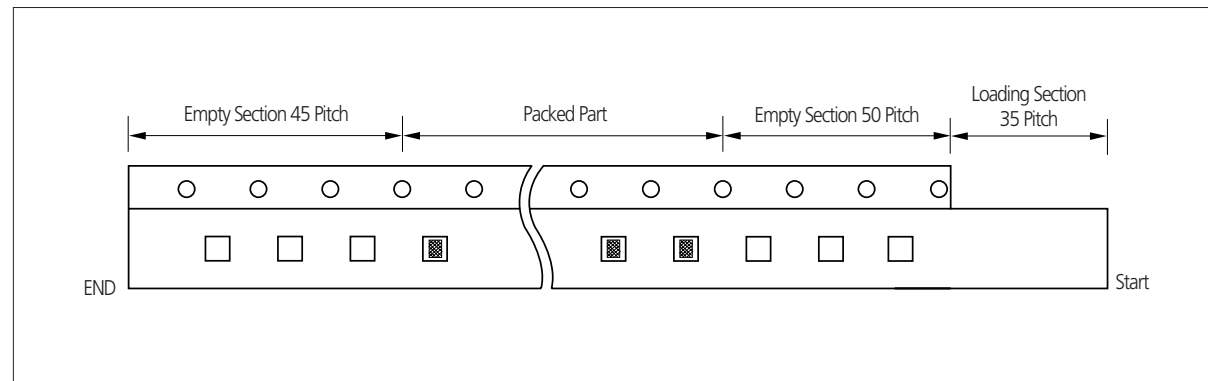

	Dimension(mm)			Quantity & Packing Code				
	Length	Width	Thickness max(mm)	Paper Type			Plastic Type	
				7"reel	10"reel	13"reel	7"reel	13"reel
General Product	0.6	0.3	$t \leq 0.33$	10,000(C)		50,000(D)		
	1.0	0.5	$t \leq 0.57$	10,000(C)	30,000(O)	50,000(D)		
	1.6	0.8	$t \leq 0.9$	4,000(C)	10,000(O)	10,000(D) 15,000(L)	2,000(E)	10,000(F)
	2.0	1.2	$t \leq 1.40$	4,000(C)	10,000(O)	10,000(D)		
			$t \leq 1.00$			15,000(L)		
			$1.00 < t \leq 1.40$				2,000(E)	10,000(F)
	3.2	1.6	$t \leq 1.80$	4,000(C)	10,000(O)	10,000(D)		10,000(F)
			$t \leq 1.00$			10,000(L)		
			$1.00 < t \leq 1.80$				2,000(E)	
			$t < 1.80$					10,000(F)
	3.2	2.5	$t = 1.80$					8,000(F)
			$t \leq 1.80$				2,000(E)	10,000(F)
			$1.80 < t \leq 2.20$				1,000(E)	8,000(F)
	4.5	2.0	$2.20 < t \leq 2.70$				1,000(E)	4,000(F)
			$t \leq 1.80$				2,000(E)	
$t \leq 2.2$						1,000(E)		
$t < 1.80$							10,000(F)	
4.5	3.2	$1.80 \leq t < 2.20$					4,000(F)	
		$t < 2.20$					4,000(F)	
		$2.20 \leq t$					2,000(F)	
	5.7	5.0	$t \leq 2.8$				2,000(F)	
Array	1.4	1.0	$t \leq 0.9$	4,000(C)	10,000(O)	10,000(D) 15,000(L)	2,000(E)	10,000(F)
	2.0	1.2	$t \leq 1.00$			15,000(L)		
	3.2	1.6	$t \leq 1.00$			10,000(L)		
Low ESL (LICC)	0.8	1.6	$t \leq 0.57$	10,000(C)	30,000(O)	50,000(D)		
	1.2	2.0	$t \leq 0.57$	10,000(C)	30,000(O)	50,000(D)		
			$t \leq 1.00$			15,000(L)		
	1.6	3.2	$t \leq 1.00$			10,000(L)		
$1.00 < t \leq 1.80$						2,000(E)		

Reel Dimensions

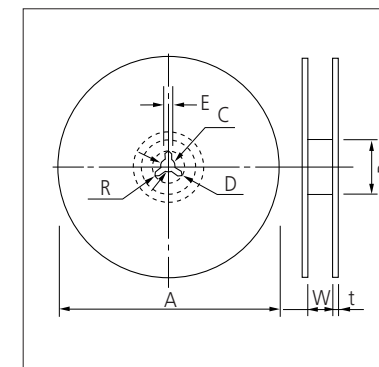

Unit: mm

Symbol	Tape Width	A	B	C	D
7" Reel	8mm	$\varnothing 180 \pm 0.3$	$\varnothing 60 \pm 1.0$	$\varnothing 13 \pm 0.3$	25 ± 0.5
	12mm	$\varnothing 180 \pm 0.3$	$\varnothing 60 \pm 1.0$	$\varnothing 13 \pm 0.3$	25 ± 0.5
13" Reel	8mm	$\varnothing 330 \pm 2.0$	$\varnothing 80 \pm 1.0$	$\varnothing 13 \pm 0.3$	25 ± 0.5
	12mm	$\varnothing 330 \pm 2.0$	$\varnothing 80 \pm 1.0$	$\varnothing 13 \pm 0.3$	25 ± 0.5

Symbol	Tape Width	E	W	t	R
7" Reel	8mm	2.0 ± 0.5	9 ± 0.5	1.2 ± 0.2	1.0
	12mm	2.0 ± 0.5	13 ± 0.5	1.2 ± 0.2	1.0
13" Reel	8mm	2.0 ± 0.5	9 ± 0.5	2.2 ± 0.2	1.0
	12mm	2.0 ± 0.5	13 ± 0.5	2.2 ± 0.2	1.0

Bulk Case Packaging

- Bulk case packaging can reduce the stock space and transportation costs.
- The bulk feeding system can increase the productivity.
- It can eliminate the components loss.

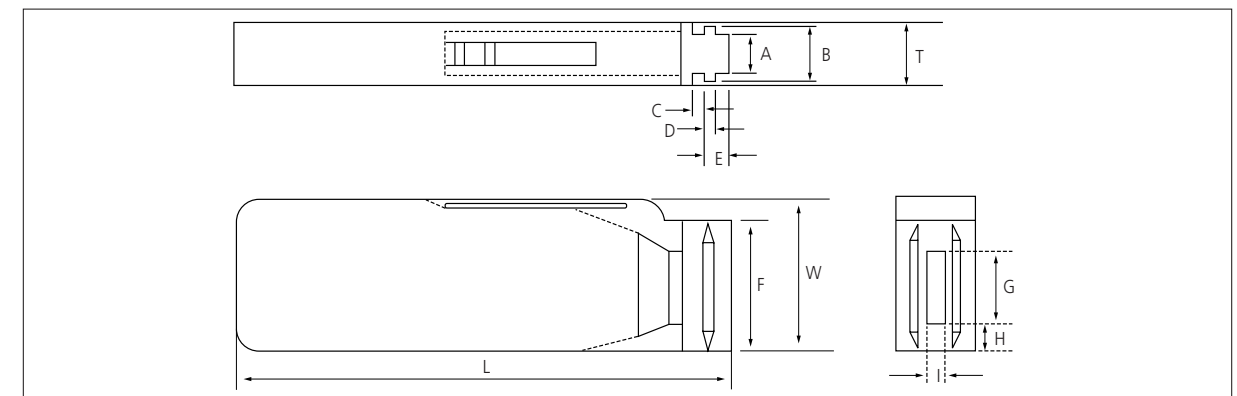

Unit: mm

Symbol	A	B	T	C	D	E
Dimension	6.8 ± 0.1	8.8 ± 0.1	12 ± 0.1	$1.5 + 0.1/-0$	$2 + 0/-0.1$	$3.0 + 0.2/-0$

Symbol	F	W	G	H	L	I
Dimension	$31.5 + 0.2/-0$	$36 + 0/-0.2$	19 ± 0.35	7 ± 0.35	110 ± 0.7	5 ± 0.35

• QUANTITY Unit: inch(mm) and pcs

Size	0402(1005)	0603(1608)	0805(2012)	
			T=0.65mm	T=0.85mm
Quantity	50,000	10,000 or 15,000	10,000	5,000 or 10,000

Reliability Test Condition

No	Item	Performance	Test Condition																											
1	Appearance	No abnormal exterior appearance	Visual Inspection through Microscope (× 10)																											
2	Insulation Resistance	10,000MΩ min. or 500MΩ · μF min. product whichever is smaller (Rated voltage ≤ 16V: 10,000MΩ min. or 100MΩ · μF min. product whichever is smaller)	Apply the rated voltage for 60~120 sec. *Rated voltage > 500V: Insulation Resistance shall be measured with 500 ± 50Vdc																											
3	Withstanding Voltage	No dielectric breakdown or mechanical breakdown	Apply the specified voltage* for 1~5 sec. Charge/Discharge current limit: 50mA max. *CLASS I (Rated Voltage < 100V): 300% of the rated Voltage CLASS II (Rated Voltage < 100V): 250% of the rated Voltage In the case of Vr ≥ 100V products, following condition should be applied. 100V ≤ Rated Voltage < 500V: 200% of the rated Voltage 500V ≤ Rated Voltage < 1000V: 150% of the rated Voltage Rated Voltage ≥ 1000V: 120% of the rated Voltage																											
4	Capacitance	CLASS I Within the specified tolerance	<table border="1"> <thead> <tr> <th>Capacitance</th> <th>Frequency</th> <th>Voltage</th> </tr> </thead> <tbody> <tr> <td>≤ 1,000pF</td> <td>1MHz ± 10%</td> <td rowspan="2">0.5 ~ 5 Vrms</td> </tr> <tr> <td>> 1,000pF</td> <td>1MHz ± 10%</td> </tr> </tbody> </table>	Capacitance	Frequency	Voltage	≤ 1,000pF	1MHz ± 10%	0.5 ~ 5 Vrms	> 1,000pF	1MHz ± 10%																			
		Capacitance	Frequency	Voltage																										
≤ 1,000pF	1MHz ± 10%	0.5 ~ 5 Vrms																												
> 1,000pF	1MHz ± 10%																													
CLASS II Within the specified tolerance	<table border="1"> <thead> <tr> <th>Capacitance</th> <th>Frequency</th> <th>Voltage</th> </tr> </thead> <tbody> <tr> <td>≤ 10μF</td> <td>1KHz ± 10%</td> <td rowspan="2">1.0 ± 0.2 Vrms</td> </tr> <tr> <td>> 10μF</td> <td>120Hz ± 20%</td> </tr> <tr> <td>*</td> <td>1KHz ± 10%</td> <td>0.5 ± 0.1 Vrms</td> </tr> </tbody> </table>	Capacitance	Frequency	Voltage	≤ 10μF	1KHz ± 10%	1.0 ± 0.2 Vrms	> 10μF	120Hz ± 20%	*	1KHz ± 10%	0.5 ± 0.1 Vrms																		
Capacitance	Frequency	Voltage																												
≤ 10μF	1KHz ± 10%	1.0 ± 0.2 Vrms																												
> 10μF	120Hz ± 20%																													
*	1KHz ± 10%	0.5 ± 0.1 Vrms																												
5	Tanδ	CLASS I Capacitance ≥ 30pF : Q ≥ 1,000 < 30pF: Q ≥ 400 + 20 × C (C : Capacitance)	<table border="1"> <thead> <tr> <th>Capacitance</th> <th>Frequency</th> <th>Voltage</th> </tr> </thead> <tbody> <tr> <td>≤ 1,000pF</td> <td>1MHz ± 10%</td> <td rowspan="2">0.5 ~ 5 Vrms</td> </tr> <tr> <td>> 1,000pF</td> <td>1KHz ± 10%</td> </tr> </tbody> </table>	Capacitance	Frequency	Voltage	≤ 1,000pF	1MHz ± 10%	0.5 ~ 5 Vrms	> 1,000pF	1KHz ± 10%																			
		Capacitance	Frequency	Voltage																										
≤ 1,000pF	1MHz ± 10%	0.5 ~ 5 Vrms																												
> 1,000pF	1KHz ± 10%																													
CLASS II	<p>1. Characteristic: A(X5R)</p> <table border="1"> <thead> <tr> <th>Rated Voltage</th> <th>Spec</th> </tr> </thead> <tbody> <tr> <td>50V / 35V</td> <td>0.025 max / 0.05 max*</td> </tr> <tr> <td>25V</td> <td>0.025 max* / 0.10 max*</td> </tr> <tr> <td>16V</td> <td>0.035 max / 0.05 max* / 0.10 max*</td> </tr> <tr> <td>≤ 10V</td> <td>0.05 max / 0.10 max*</td> </tr> </tbody> </table> <p>2. Characteristic: B(X7R), X(X6S)</p> <table border="1"> <thead> <tr> <th>Rated Voltage</th> <th>Spec</th> </tr> </thead> <tbody> <tr> <td>50V / 35V / 25V</td> <td>0.025 max / 0.05 max* / 0.10 max*</td> </tr> <tr> <td>16V</td> <td>0.035 max / 0.10 max*</td> </tr> <tr> <td>≤ 10V</td> <td>0.05 max / 0.10 max*</td> </tr> </tbody> </table> <p>3. Characteristic: F(Y5V)</p> <table border="1"> <thead> <tr> <th>Rated Voltage</th> <th>Spec</th> </tr> </thead> <tbody> <tr> <td>50V / 35V / 25V</td> <td>0.05 max / 0.07 max* / 0.09 max*</td> </tr> <tr> <td>16V</td> <td>0.07 max / 0.09 max* / 0.125 max*</td> </tr> <tr> <td>10V</td> <td>0.125 max / 0.16 max*</td> </tr> <tr> <td>≤ 6.3V</td> <td>0.16 max</td> </tr> </tbody> </table>	Rated Voltage	Spec	50V / 35V	0.025 max / 0.05 max*	25V	0.025 max* / 0.10 max*	16V	0.035 max / 0.05 max* / 0.10 max*	≤ 10V	0.05 max / 0.10 max*	Rated Voltage	Spec	50V / 35V / 25V	0.025 max / 0.05 max* / 0.10 max*	16V	0.035 max / 0.10 max*	≤ 10V	0.05 max / 0.10 max*	Rated Voltage	Spec	50V / 35V / 25V	0.05 max / 0.07 max* / 0.09 max*	16V	0.07 max / 0.09 max* / 0.125 max*	10V	0.125 max / 0.16 max*	≤ 6.3V	0.16 max	You can check the specification at the web site or contact sales people for each product with mark*
Rated Voltage	Spec																													
50V / 35V	0.025 max / 0.05 max*																													
25V	0.025 max* / 0.10 max*																													
16V	0.035 max / 0.05 max* / 0.10 max*																													
≤ 10V	0.05 max / 0.10 max*																													
Rated Voltage	Spec																													
50V / 35V / 25V	0.025 max / 0.05 max* / 0.10 max*																													
16V	0.035 max / 0.10 max*																													
≤ 10V	0.05 max / 0.10 max*																													
Rated Voltage	Spec																													
50V / 35V / 25V	0.05 max / 0.07 max* / 0.09 max*																													
16V	0.07 max / 0.09 max* / 0.125 max*																													
10V	0.125 max / 0.16 max*																													
≤ 6.3V	0.16 max																													

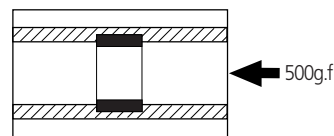
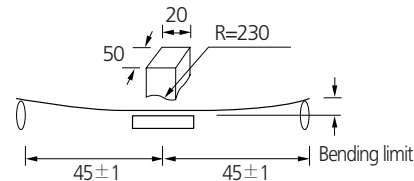
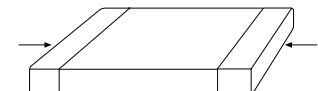
No	Item	Performance	Test Condition																													
6	Temperature Characteristics of Capacitance	CLASS I	<table border="1"> <thead> <tr> <th>Characteristic</th> <th>Temp. Coefficient (PPM/°C)</th> </tr> </thead> <tbody> <tr> <td>C</td> <td>0 ± 30</td> </tr> <tr> <td>P</td> <td>-150 ± 60</td> </tr> <tr> <td>R</td> <td>-220 ± 60</td> </tr> <tr> <td>S</td> <td>-330 ± 60</td> </tr> <tr> <td>T</td> <td>-470 ± 60</td> </tr> <tr> <td>U</td> <td>-750 ± 120</td> </tr> <tr> <td>S</td> <td>+350 ~ -1000</td> </tr> </tbody> </table>	Characteristic	Temp. Coefficient (PPM/°C)	C	0 ± 30	P	-150 ± 60	R	-220 ± 60	S	-330 ± 60	T	-470 ± 60	U	-750 ± 120	S	+350 ~ -1000	<p>Capacitance shall be measured by the steps shown in the following table.</p> <table border="1"> <thead> <tr> <th>Step</th> <th>Temperature (°C)</th> </tr> </thead> <tbody> <tr> <td>1</td> <td>25 ± 2</td> </tr> <tr> <td>2</td> <td>Min. Operating Temp. ± 2</td> </tr> <tr> <td>3</td> <td>25 ± 2</td> </tr> <tr> <td>4</td> <td>Max. Operating Temp. ± 2</td> </tr> <tr> <td>5</td> <td>25 ± 2</td> </tr> </tbody> </table> <p>(1) CLASS I Temperature Coefficient shall be calculated from the formula as below Temp. Coefficient = $\frac{C2 - C1}{C1 \times \Delta T} \times 10^6$ [ppm/°C] C1: Capacitance at step 3 C2: Capacitance at 85°C ΔT: 60°C (= 85°C - 25°C)</p> <p>(2) CLASS II Capacitance Change shall be calculated from the formula as below $\Delta C = \frac{C2 - C1}{C1} \times 100$ (%) C1: Capacitance at step 3 C2: Capacitance at step 2 or 4</p>	Step	Temperature (°C)	1	25 ± 2	2	Min. Operating Temp. ± 2	3	25 ± 2	4	Max. Operating Temp. ± 2	5	25 ± 2
		Characteristic	Temp. Coefficient (PPM/°C)																													
C	0 ± 30																															
P	-150 ± 60																															
R	-220 ± 60																															
S	-330 ± 60																															
T	-470 ± 60																															
U	-750 ± 120																															
S	+350 ~ -1000																															
Step	Temperature (°C)																															
1	25 ± 2																															
2	Min. Operating Temp. ± 2																															
3	25 ± 2																															
4	Max. Operating Temp. ± 2																															
5	25 ± 2																															
CLASS II	<table border="1"> <thead> <tr> <th>Characteristic</th> <th>Capacitance Change (%) with No bias</th> </tr> </thead> <tbody> <tr> <td>A(X5R) / B(X7R)</td> <td>± 15%</td> </tr> <tr> <td>X(X6S)</td> <td>± 22%</td> </tr> <tr> <td>F(Y5V)</td> <td>+22% ~ -82%</td> </tr> </tbody> </table>	Characteristic	Capacitance Change (%) with No bias	A(X5R) / B(X7R)	± 15%	X(X6S)	± 22%	F(Y5V)	+22% ~ -82%																							
Characteristic	Capacitance Change (%) with No bias																															
A(X5R) / B(X7R)	± 15%																															
X(X6S)	± 22%																															
F(Y5V)	+22% ~ -82%																															
7	Adhesive Strength of Termination	No indication of peeling shall occur on the terminal electrode	<p>Apply 500g.f* pressure for 10 ± 1 sec. *200g.f for 0201</p> 																													
8	Bending Strength	Appearance	No indication of peeling shall occur																													
		Capacitance	<table border="1"> <thead> <tr> <th>Characteristic</th> <th>Capacitance Change</th> </tr> </thead> <tbody> <tr> <td>CLASS I</td> <td>± 5% or ± 0.5 pF whichever is larger</td> </tr> <tr> <td>CLASS II</td> <td> <table border="1"> <tbody> <tr> <td>A(X5R), B(X7R), X(X6S)</td> <td>± 12.5%</td> </tr> <tr> <td>F(Y5V)</td> <td>± 30%</td> </tr> </tbody> </table> </td> </tr> </tbody> </table>	Characteristic	Capacitance Change	CLASS I	± 5% or ± 0.5 pF whichever is larger	CLASS II	<table border="1"> <tbody> <tr> <td>A(X5R), B(X7R), X(X6S)</td> <td>± 12.5%</td> </tr> <tr> <td>F(Y5V)</td> <td>± 30%</td> </tr> </tbody> </table>	A(X5R), B(X7R), X(X6S)	± 12.5%	F(Y5V)	± 30%	<p>• Bending Limit: 1mm • Test Speed: 1.0mm/sec. • Keep the test board at the limit point in 5 sec. • Then Measure Capacitance</p> 																		
Characteristic	Capacitance Change																															
CLASS I	± 5% or ± 0.5 pF whichever is larger																															
CLASS II	<table border="1"> <tbody> <tr> <td>A(X5R), B(X7R), X(X6S)</td> <td>± 12.5%</td> </tr> <tr> <td>F(Y5V)</td> <td>± 30%</td> </tr> </tbody> </table>	A(X5R), B(X7R), X(X6S)	± 12.5%	F(Y5V)	± 30%																											
A(X5R), B(X7R), X(X6S)	± 12.5%																															
F(Y5V)	± 30%																															
9	Solderability	More than 95% of the terminal surface is to be soldered newly, so metal part does not come out or dissolve	 <table border="1"> <tbody> <tr> <td>Solder</td> <td>Sn-3Ag-0.5Cu</td> <td>63Sn-37Pb</td> </tr> <tr> <td>Solder Temp.</td> <td>245 ± 5°C</td> <td>235 ± 5°C</td> </tr> <tr> <td>Flux</td> <td colspan="2">RMA Type</td> </tr> <tr> <td>Dip time</td> <td>3 ± 0.3 sec.</td> <td>5 ± 0.5 sec.</td> </tr> <tr> <td>Pre-heating</td> <td colspan="2">at 80~120°C for 10~30 sec.</td> </tr> </tbody> </table>	Solder	Sn-3Ag-0.5Cu	63Sn-37Pb	Solder Temp.	245 ± 5°C	235 ± 5°C	Flux	RMA Type		Dip time	3 ± 0.3 sec.	5 ± 0.5 sec.	Pre-heating	at 80~120°C for 10~30 sec.															
Solder	Sn-3Ag-0.5Cu	63Sn-37Pb																														
Solder Temp.	245 ± 5°C	235 ± 5°C																														
Flux	RMA Type																															
Dip time	3 ± 0.3 sec.	5 ± 0.5 sec.																														
Pre-heating	at 80~120°C for 10~30 sec.																															
10	Resistance to Soldering Heat	Appearance	No mechanical damage shall occur	<p>Solder temperature: 270 ± 5°C DIP TIME: 10 ± 1 sec. Each termination shall be fully immersed and preheated as below:</p> <table border="1"> <thead> <tr> <th>Step</th> <th>Temperature (°C)</th> <th>Time (sec.)</th> </tr> </thead> <tbody> <tr> <td>1</td> <td>80~100</td> <td>60</td> </tr> <tr> <td>2</td> <td>150~180</td> <td>60</td> </tr> </tbody> </table> <p>Leave the capacitor in ambient condition for specified time* before measurement *24 ± 2 hours (CLASS I) 48 ± 4 hours (CLASS II)</p>	Step	Temperature (°C)	Time (sec.)	1	80~100	60	2	150~180	60																			
		Step	Temperature (°C)		Time (sec.)																											
	1	80~100	60																													
	2	150~180	60																													
	Capacitance	<table border="1"> <thead> <tr> <th>Characteristic</th> <th>Capacitance Change</th> </tr> </thead> <tbody> <tr> <td>CLASS I</td> <td>± 2.5% or ± 0.25 pF whichever is larger</td> </tr> <tr> <td>CLASS II</td> <td> <table border="1"> <tbody> <tr> <td>A(X5R), B(X7R)</td> <td>± 7.5%</td> </tr> <tr> <td>X(X6S)</td> <td>± 15%</td> </tr> <tr> <td>F(Y5V)</td> <td>± 20%</td> </tr> </tbody> </table> </td> </tr> </tbody> </table>	Characteristic		Capacitance Change	CLASS I	± 2.5% or ± 0.25 pF whichever is larger	CLASS II	<table border="1"> <tbody> <tr> <td>A(X5R), B(X7R)</td> <td>± 7.5%</td> </tr> <tr> <td>X(X6S)</td> <td>± 15%</td> </tr> <tr> <td>F(Y5V)</td> <td>± 20%</td> </tr> </tbody> </table>	A(X5R), B(X7R)	± 7.5%	X(X6S)	± 15%	F(Y5V)	± 20%																	
	Characteristic	Capacitance Change																														
CLASS I	± 2.5% or ± 0.25 pF whichever is larger																															
CLASS II	<table border="1"> <tbody> <tr> <td>A(X5R), B(X7R)</td> <td>± 7.5%</td> </tr> <tr> <td>X(X6S)</td> <td>± 15%</td> </tr> <tr> <td>F(Y5V)</td> <td>± 20%</td> </tr> </tbody> </table>	A(X5R), B(X7R)	± 7.5%	X(X6S)	± 15%	F(Y5V)	± 20%																									
A(X5R), B(X7R)	± 7.5%																															
X(X6S)	± 15%																															
F(Y5V)	± 20%																															
Q (CLASS I)	Within the specified initial value																															
Tanδ (CLASS II)	Within the specified initial value																															
Insulation resistance	Within the specified initial value																															
Withstanding voltage	Within the specified initial value																															

No	Item	Performance	Test Condition	
11	Vibration Test	Appearance	No mechanical damage shall occur	
		Capacitance	Characteristic	Capacitance Change
			CLASS I	±2.5% or ± 0.25 pF whichever is larger
		CLASS II	A(X5R), B(X7R)	±5%
			X(X6S)	±10%
			F(Y5V)	±20%
Q (CLASS I)	Within the specified initial value			
Tanδ (CLASS II)	Within the specified initial value			
Insulation resistance	Within the specified initial value			
12	Humidity (Steady state)	Appearance	No mechanical damage shall occur	
		Capacitance	Characteristic	Capacitance Change
			CLASS I	±5% or ± 0.5 pF whichever is larger
		CLASS II	A(X5R), B(X7R), X(X6S)	±12.5%
			F(Y5V)	±30% / +30~-40%*
			Q (CLASS I)	Capacitance ≥ 30pF : Q ≥ 350 10 ≤ Capacitance < 30pF : Q ≥ 275+2.5 × C Capacitance < 10pF : Q ≥ 200+10 × C (C: Capacitance)
Tanδ (CLASS II)	1.Characteristic: A(X5R) 0.05 max / 0.075 max* (35V / 50V) 0.05 max / 0.075 max* / 0.125 max*(16V / 25V) 0.075 max / 0.125 max* (≤ 10V) 2.Characteristic: B(X7R), X(X6S) 0.05 max / 0.125 max* (16V / 25V / 35V / 50V) 0.075 max / 0.125 max* (≤ 10V) 3.Characteristic: F(Y5V) 0.09 max (50V) 0.09 max / 0.125 max* (25V / 35V) 0.09 max / 0.125 max* / 0.16 max* (16V) 0.16 max / 0.195 max* (10V) 0.195 max (4V / 6.3V)			
Insulation resistance	1,000MΩ min. or 50MΩ · μF min. product whichever is smaller / 25MΩ · μF or over*			
13	Moisture Resistance	Appearance	No mechanical damage shall occur	
		Capacitance	Characteristic	Capacitance Change
			CLASS I	±7.5% or ± 0.75pF whichever is larger
		CLASS II	A(X5R), B(X7R), X(X6S)	±12.5%
			F(Y5V)	±30% / +30~-40%*
			Q (CLASS I)	Capacitance ≥ 30pF : Q ≥ 200 < 30pF : Q ≥ 100+10/3 × C (C: Capacitance)
Tanδ (CLASS II)	1.Capacitance: A(X5R) 0.05 max / 0.075 max* (35V / 50V) 0.05 max / 0.075 max* / 0.125 max*(16V / 25V) 0.075 max / 0.125 max* (≤ 10V) 2.Capacitance: B(X7R), X(X6S) 0.05 max / 0.125 max* (16V / 25V / 35V / 50V) 0.075 max / 0.125 max* (≤ 10V) 3.Capacitance: F(Y5V) 0.09 max (50V) 0.09 max / 0.125 max* (25V / 35V) 0.09 max / 0.125 max* / 0.16 max* (16V) 0.16 max / 0.195 max* (10V) 0.195 max (4V / 6.3V)			
Insulation resistance	500MΩ min. or 25MΩ · μF min. product whichever is smaller / 12.5MΩ · μF or over*			

No	Item	Performance	Test Condition	
14	High Temperature Resistance	Appearance	No mechanical damage shall occur	
		Capacitance	Characteristic	Capacitance Change
			CLASS I	±3% or ± 0.3 pF whichever is larger
		CLASS II	A(X5R), B(X7R)	±12.5%
			X(X6S)	±25%
			F(Y5V)	±30% ±30% / +30~-40%*
Q (CLASS I)	Capacitance ≥ 30pF : Q ≥ 350 10 ≤ Capacitance < 30pF : Q ≥ 275+2.5 × C Capacitance < 10pF : Q ≥ 200+10 × C (C: Capacitance)			
Tanδ (CLASS II)	1.Capacitance: A(X5R) 0.05 max / 0.075 max* (35V / 50V) 0.05 max / 0.075 max* / 0.125 max*(16V / 25V) 0.075 max / 0.125 max* (≤ 10V) 2.Capacitance: B(X7R), X(X6S) 0.05 max / 0.125 max* (16V / 25V / 35V / 50V) 0.075 max / 0.125 max* (≤ 10V) 3.Capacitance: F(Y5V) 0.09 max (50V) 0.09 max / 0.125 max* (25V / 35V) 0.09 max / 0.125 max* / 0.16 max* (16V) 0.16 max / 0.195 max* (10V) 0.195 max (4V / 6.3V)			
Insulation resistance	1,000MΩ min. or 50MΩ · μF min. product whichever is smaller / 25MΩ · μF or over*			
15	Temperature Cycle	Appearance	No mechanical damage shall occur	
		Capacitance	Characteristic	Capacitance Change
			CLASS I	±2.5% or ± 0.25pF whichever is larger
		CLASS II	A(X5R), B(X7R)	±7.5%
			X(X6S)	±15%
			F(Y5V)	±20%
Q (CLASS I)	Within the specified initial value			
Tanδ (CLASS II)	Within the specified initial value			
Insulation resistance	Within the specified initial value			

Applied Voltage: 200%* of the rated voltage
Temperature: max. operating temperature
Duration Time: 1000+48/0 Hr.
Charge/Discharge Current: 50mA max.

Rated Voltage < 250V: 200% of the rated Voltage
500V ≤ rated voltage < 1000V: 120% of the rated Voltage
1000V ≤ rated voltage ≤ 3000V: 100% of the rated Voltage
* : 150% / 100% of the rated Voltage

Perform the initial measurement according to Note1 for class II

Perform the final measurement according to Note2.

You can check the specification at the web site or contact sales people for each product with mark*

Capacitor shall be subjected to 5 cycles.
Condition for 1 cycle:

Step	Temperature(°C)	Time(min.)
1	min. operating temperature +0/-3	30
2	25	2~3
3	max. operating temperature +0/-3	30
4	25	2~3

Leave the capacitor in ambient condition for specified time* before measurement
*24 ± 2 hours(CLASS I)
48 ± 4 hours(CLASS II)

No	Recommended Soldering Method					
	Size inch(mm)	Temperature Characteristic	Capacitance	Condition		
				Flow	Reflow	
16	Recommended Soldering Method By Size & Capacitance	0201 (0603)	-	-	-	○
		0402 (1005)				
		0603(1608)	Class I	-	○	○
			Class II	C < 1μF	○	○
		0805 (2012)	Class II	C ≥ 1μF	-	○
				Class I	-	○
			Class II	C < 4.7μF	○	○
				C ≥ 4.7μF	-	○
		1206 (3216)	Array	-	-	○
			Class I	-	○	○
			Class II	C < 10μF	○	○
		C ≥ 10μF		-	○	
		1210 (3225)	Array	-	-	○
		1808 (4520)	-	-	-	○
1812 (4532)	-	-	-	○		
2220 (5750)	-	-	-	○		

Note1. Initial Measurement For Class II

Perform the heat treatment at 150°C+0/-10°C for 1 hour. Then Leave the capacitor in ambient condition for 48±4 hours before measurement. Then perform the measurement.

Note2. Latter Measurement

- CLASS I**
Leave the capacitor in ambient condition for 24±2 hours before measurement. Then perform the measurement.
- CLASSII**
Perform the heat treatment at 150°C+0/-10°C for 1 hour. Then Leave the capacitor in ambient condition for 48±4 hours before measurement. Then perform the measurement.

Note3. All Size in Reliability Test Condition Section is "inch"

1.Storage of products

1-1. Storage Environment

Tape packing materials are designed to withstand long-term storage, but they will degrade more rapidly in the presence of high temperature or high humidity. Therefore, the products must be stored in an ambient 5~40°C with a relative humidity of 20~70%. Allowable storage period is within 6 months from the outgoing date of delivery.

1-2. Corrosive Gases

Since sulfur and chlorine may degrade the solderability of the end termination, it is important to store the capacitors in an environment free of these gases

1-3. Temperature Fluctuations

Since dew condensation may occur by the differences in temperature when the products are taken out of storage, it is important to maintain a temperature-controlled environment.

2.Design of Solder Land Pattern

When designing printed circuit boards, the shape and size of the solder lands must allow for the proper amount of solder on the capacitor. The amount of solder at the end terminations has a direct effect on the probability that the chip will crack. The greater amount of solder, the larger amount of stress on the chip, and the more likely that it will break. Use the following illustrations as guidelines for proper Solder land design.

Recommendation of solder Land Shape and Size

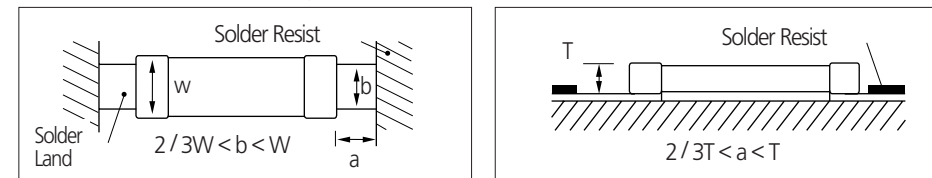

3.Adhesives

MLCCs generally require the use of an adhesive to position the chips to the circuit board prior to soldering.

3-1. Requirements for Adhesives

- They must have enough adhesion so that the chips will not fall off or move during the handling of the circuit board.
- They must maintain their adhesive strength when exposed to soldering temperatures.
- They should not spread or run when applied to the circuit board.
- They should have a long pot life.
- They should harden quickly.
- They should not corrode the circuit board or chip material.
- They should be a good insulator.
- They should be non-toxic, and not produce harmful gases, nor be harmful when touched.

3-2. Application Method

It is important to use the proper amount of adhesive. Too little will cause poor adhesion to the circuit board, and too much may strain the conductor pattern, thereby causing defective soldering. The following illustrations show the proper quantity of adhesive.

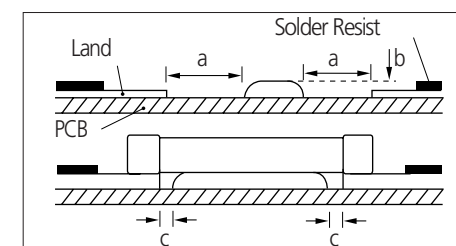

Unit: mm		
Type	21	31
a	0.2min	0.2min
b	70~100μm	70~100μm
c	>0	>0

3-3. Adhesive hardening Characteristics

To prevent oxidation of the terminations, the adhesive must harden at 160°C or less, within 2 minutes or less.

4. Mounting

4-1. Mounting Head Pressure

Excessive pressure will cause chip capacitors to crack. The pressure between nozzle and chip capacitor will be 300g maximum during mounting.

4-2. Bending Stress

Bending of printed circuit board by mounting head when double-sided circuit boards are used, chip capacitors first are mounted and soldered onto one side of the board. When the capacitors are mounted onto the other side, it is important to support the board as shown in the illustration. If the circuit board is not supported, it may bend, causing the already-installed capacitors to crack.

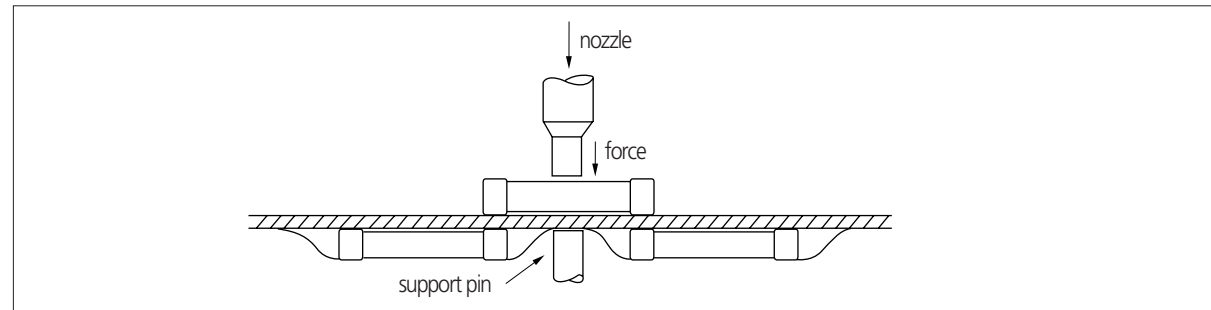

5. Flux

Although highly-activated flux gives better solderability, substances which increase activity may also degrade the insulation of the chip capacitors. To avoid such degradation, it is recommended that a mildly activated rosin flux (less than 0.2% chlorine) be used.

6. Soldering

Since a multilayer ceramic chip capacitor comes into direct contact with melted solder during soldering, it is exposed to potentially mechanical stress caused by the sudden temperature change. The capacitor may also be subject to silver migration, and to contamination by the flux. Because of these factors, soldering technique is critical.

6-1. Soldering Methods

Method	Classification	
Reflow soldering	· Overall heating	· Infrared rays · Hot plate · VPS (Vapor phase)
	· Local heating	· Air heater · Laser · Light beam
Flow Soldering	· Single wave · Double wave	

6-2. Soldering Profile

To avoid the crack problem by sudden temperature change, follow the temperature profile in the adjacent graph.

6-2-1 Pb-Free (Sn 100%) Plating

REFLOW SOLDERING

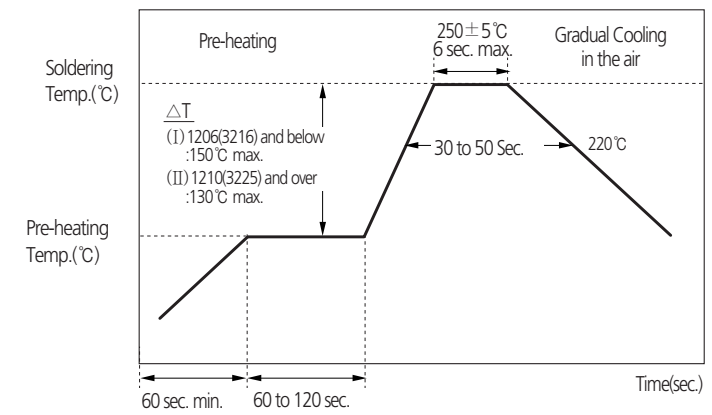

FLOW SOLDERING

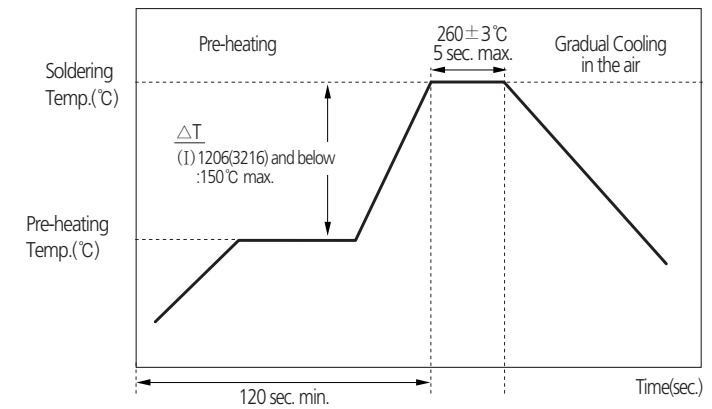

SOLDER IRON (Hand Soldering)

Variation of Temp.(°C)	Soldering Temp(°C)	Pre-heating Time(sec)	Soldering Time(sec)	Cooling Time(sec)	Condition of Iron Facilities		
					Wattage	Tip Diameter	Soldering Time
ΔT ≤ 130	300 ± 10 °C max	≥ 60 sec.	≤ 4 sec.	-	20W max	3mm max	4 sec max

6-3. Manual Soldering

Manual soldering can pose a great risk of creating thermal cracks in chip capacitors. The hot soldering iron tip comes into direct contact with the end terminations, and operator's carelessness may cause the tip of the soldering iron to come into direct contact with the ceramic body of the capacitor. Therefore the soldering iron must be handled carefully, and close attention must be paid to the selection of the soldering iron tip and to temperature control of the tip.

6-4. Amount of Solder

Too much Solder

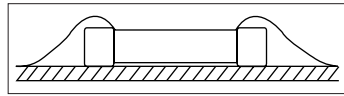

Cracks tend to occur due to large stress.

Not enough solder

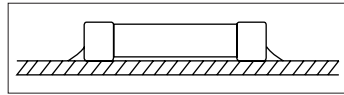

Weak holding force may cause bad connections or detaching of the capacitor

6-5. Cooling

Natural cooling using air is recommended. If the chips are dipped into solvent for cleaning, the temperature difference (ΔT) must be less than 100°C

6-6. Cleaning

If rosin flux is used, cleaning usually is unnecessary. When strongly activated flux is used, chlorine in the flux may dissolve into some types of cleaning fluids, thereby affecting the chip capacitors. This means that the cleaning fluid must be carefully selected, and should always be new.

7. Notes for Separating Multiple, Shared PC Boards

A multi-PC board is separated into many individual circuit boards after soldering has been completed. If the board is bent or distorted at the time of separation, cracks may occur in the chip capacitors. Carefully choose a separation method that minimizes the bending of the circuit board.